

# Catalyzing the Growth of Electronic Monitoring in Fisheries

## Building Greater Transparency and Accountability at Sea

Opportunities, Barriers, and Recommendations for Scaling the Technology

**CEA** CALIFORNIA ENVIRONMENTAL ASSOCIATES

Mark Michelin | Matthew Elliott | Max Bucher

The Nature Conservancy   
nature.org

Mark Zimring | Mike Sweeney

# Catalyzing the Growth of Electronic Monitoring in Fisheries

## Building Greater Transparency and Accountability at Sea

Opportunities, Barriers, and Recommendations for Scaling the Technology

## Contents

Acronyms	3
<b>Executive Summary</b>	<b>4</b>
About this Report	7
Lost at Sea	8
Vision	9
<b>Background on EM</b>	<b>10</b>
What Is EM?	10
A Brief History of EM	11
<b>The Future of the EM Market</b>	<b>14</b>
<b>The Benefits of EM</b>	<b>16</b>
Improving Data Integrity and Compliance	16
Enabling Incentive-Based Management	20
Building Shared Trust in Fisheries-Dependent Data	21
Operational Benefits of EM	22
Seafood Market Benefits from EM	22
Benefits of EM Compared to Human Observers	26
Data Quality	28
<b>Barriers to EM Market Growth</b>	<b>30</b>
1) Cost	31
Recommendations to Support EM Cost	
Reductions and Technological Advancements	39
2) Regulator Concerns	40
Recommendations to Build Regulator	
Support for EM	42
3) Fishermen and Seafood Industry Concerns	45
Recommendations to Build Fishermen and	
Seafood Industry Support for EM and Cultivate	
Private-Sector Leadership	47
<b>Near-Term Priorities to Advance EM</b>	<b>49</b>
<b>EM Priorities for the Next 3+ Years</b>	<b>51</b>
Appendix A - Future EM Scenario Assumptions	53
Appendix B - EM Vendors and Service Providers	54
Appendix C - Summary of Studies Comparing EM and Human Observers	56
Appendix D - EM Data Lifecycle & System Design Considerations	59
References	60
Bibliography	62



**CEA** CALIFORNIA ENVIRONMENTAL ASSOCIATES

The Nature Conservancy   
nature.org

# Catalyzing the Growth of Electronic Monitoring in Fisheries

## Building Greater Transparency and Accountability at Sea

Opportunities, Barriers, and Recommendations for Scaling the Technology

### Acronyms

AI	Artificial Intelligence
AIS	Automatic Identification System
CCAMLR	Commission for the Conservation of Antarctic Marine Living Resources
CPUE	Catch per Unit Effort
EM	Electronic Monitoring
ETP	Endangered, Threatened, or Protected Species
EU	European Union
FAD	Fish Aggregating Device
FFA	Pacific Islands Forum Fisheries Agency
FIP	Fishery Improvement Project
GPS	Global Positioning System
HMS	Highly Migratory Species
HO	Human Observer
IATTC	Inter-American Tropical Tuna Commission
IBQ	Individual Bluefin Quota
ICES	International Council for the Exploration of the Sea
IEMRS	Integrated Electronic Monitoring and Reporting System
IOTC	Indian Ocean Tuna Commission
IFQ	Individual Fishing Quota
IT	Information Technology
ITQ	Individual Transferable Quotas
IUU	Illegal, Unreported, and Unregulated
IVQ	Individual Vessel Quota
MSC	Marine Stewardship Council
NGO	Nongovernmental Organization
NOAA	National Oceanic and Atmospheric Administration
PNA	Parties to the Nauru Agreement
PRI	Program-Related investment
PSMFC	Pacific States Marine Fisheries Commission
RAP	Regulatory Assistance Project
RCA	Rockfish Conservation Area
RFMO	Regional Fisheries Management Organization
RFQ	Request for Quotation
SIMP	Seafood Import Monitoring Program
US	United States
VMS	Vessel Monitoring System
WCPFC	Western and Central Pacific Fisheries Commission

CALIFORNIA  
**CEA** ENVIRONMENTAL  
 ASSOCIATES

The Nature  
 Conservancy   
 nature.org



## Executive Summary

It has been nearly twenty years since the first trials of electronic monitoring (EM) in fisheries took place in British Columbia. Today, there are approximately 1 thousand EM systems installed on fishing vessels worldwide in a combination of pilots and full-fledged programs. EM, however, appears to be at a critical moment in its development. Growing experience with EM program design and implementation and technological advancement are increasing the confidence in the tool. Simultaneously, fisheries are facing a steady ratcheting up of regulatory and market demands for transparency and accountability. EM has the potential to help meet this demand for more robust fisheries data and dramatically improve fisheries monitoring and accountability in the coming decade.

**Many fisheries lack the reliable data that is the cornerstone of effective management.** Many fisheries lack reliable data about what happens on the water to inform and implement science-based management. Many also lack the political will, management and legal frameworks, capacity, and compliance tools necessary for enforcement. The World Bank estimates that this results in over \$80 billion less in annual net benefits than if fisheries were managed sustainably.<sup>3</sup> Improved data collection and the ability to enforce regulations is an important starting point in addressing this imbalance. At sea, human observers have been a valuable tool for collecting the essential data for effective management, but they cover just a tiny fraction of global fishing effort and face considerable safety risks. Tackling these problems at scale will ultimately require embracing the technologies that are transforming other industries.

**EM can be a game changer that provides the robust and granular data necessary for sustainable and efficient fisheries management.** EM, which is defined in this report as an integrated system of cameras and sensors on fishing vessels, can provide a comprehensive record of fishing activity that can inform fisheries management and ensure compliance with regulations. There are a variety of tools being used to fill the large gaps in fisheries and oceans data ranging from more traditional human observers and dockside monitoring programs to new technologies, such as sail drones. EM, however, is unique in the comprehensive accountability and granularity of data it can provide on fisheries activities. This makes EM a game changer in its ability to address some of the most vexing fisheries management challenges.



**For many fishery data needs, EM can be more reliable, cost-effective, and more easily scaled to cover 100 percent of fishing activity than human observers.** Available evidence demonstrates that EM can increase monitoring coverage and improve data robustness and compliance, allowing fisheries managers to enact more efficient regulations and reduce uncertainty. EM data can provide a foundation for fundamental research applications, ranging from stock assessments to assessing the efficacy of harvest strategies to providing inputs to ecosystem models. With verifiable information about what is happening on the water, EM systems have helped to build shared trust in the data used to inform fisheries management between industry and regulators. Across programs, they have demonstrated effectiveness at monitoring for discards, catch enumeration, endangered, threatened, or protected species (ETP) interactions, catch handling processes, protected area compliance, and use of bycatch mitigation measures. In many fisheries, EM systems can achieve this more cost-effectively than human observers and can more easily scale to cover 100 percent of fishing activity. EM data is also less susceptible to bias from changes in fishing practices while being observed (observer effects), non-random selection of trips to observe (deployment effects), intimidation of observers, and corruption. EM is not the right tool for every fishery or at-sea data requirement – EM is more effective for fisheries that bring catch on board serially, and cameras cannot do biological sampling – but there are many fisheries where EM can cost-effectively meet critical data needs. The applicability of the tool will only grow as technological advances improve capabilities and reduce costs.

**In the longer term, we anticipate that EM will provide tangible market and operational benefits to seafood industry participants.** EM has the promise to improve traceability, demonstrate adherence to sustainability and social responsibility claims that can provide premium market access, and deliver robust data for business analytics. EM can help seafood supply chains mitigate risk by providing transparency from catch to dock, which is a missing link in almost all of the traceability efforts being promoted in the seafood marketplace today. Without on-the-water transparency, companies can trace fish from the point of landing but may have no assurance that the fish was caught legally or in accordance with required sustainability standards. Cultivating and demonstrating the market and operational benefits of EM will increase seafood industry demand for the tool.

**Cost, regulator concerns, fishermen and seafood industry concerns, and technological limitations have held back the growth of EM to date.** Approximately 1 thousand EM systems have been installed over the last two decades and, on its current trajectory, EM will be installed on roughly 5 thousand more vessels in the coming decade. But, there is a strong case to push for more rapid adoption. There is immense value in the information that EM can provide for all fisheries stakeholders, including fishermen, industry, regulators, and nongovernmental organizations (NGOs), but this has not been widely demonstrated or fully understood by these potential EM customers. We identify several major barriers to the wide-scale adoption of EM: cost, regulator concerns, fisher and seafood industry concerns, and technological limitations.

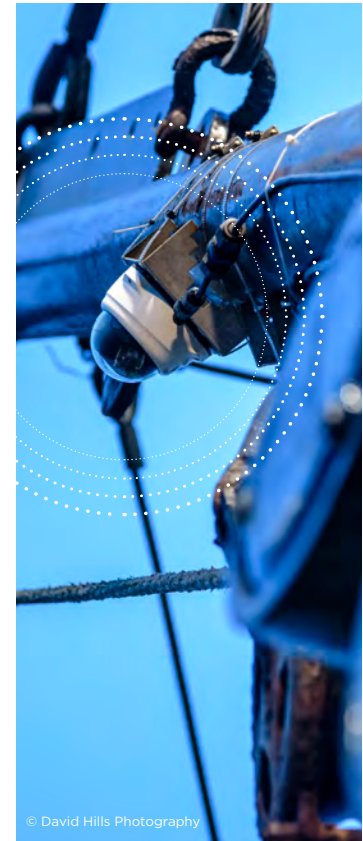

- Cultivating and demonstrating the market and operational benefits of EM will increase seafood industry demand for the tool.

**EM is at an inflection point and a more concerted and coordinated effort to overcome the barriers to adoption can catalyze rapid growth of the tool.** With growing recognition of the potential of EM to improve fisheries management, there is a flurry of interest in EM spanning countries and regions from the United States (US) and Europe to the Pacific Islands. But, for EM to realize its full market potential, more work is needed to demonstrate the benefits of the tool, identify new opportunities for the technology, and break down the barriers that are slowing adoption. To help overcome these barriers, we have compiled a set of recommendations from the field, grouped in four areas:

- **Support EM Cost Reductions and Technological Advancements**
- **Build Broad Demand for EM Through National and Regional Prioritization of EM**
- **Assist Regulators with EM Program Design and Implementation**
- **Build Fishermen and Industry Support for EM and Cultivate Private-Sector Leadership**

A coordinated effort in each of these areas is needed to dramatically increase the growth of EM. With a more concerted effort to promote the tool, it can reach more than 11 thousand fishing vessels in the next ten years, and this only includes fisheries that are already considering EM as an option. But, EM is at an inflection point, and with stronger support, it can become a standard practice for high-value fisheries in strong governance regions around the world and begin to gain a foothold in some of the more challenging but globally significant fishing regions (e.g., Indonesia, North Asia, S. Europe). This could amount to more than 25 thousand vessels equipped with EM in the next decade bringing cost-effective accountability and robust data to many of the world's most important fisheries.

**The true benefits of EM will be realized when the data it provides is used to improve fisheries management and unlock value in the seafood market.** EM installations are not an end point in and of themselves. The true value of EM will be unlocked when the data it provides is used to implement more efficient, targeted, and adaptive management measures and help stamp out illegal, unreported, and unregulated (IUU) fishing in increasingly uncertain times. A laudable goal is for fishermen, managers, and seafood supply chains to be able to seamlessly report and review data with the touch of a button, which has the potential to improve fisheries management and generate value for industry in the seafood marketplace. There is a need to modernize fisheries management, collect reliable data on fishing operations at sea, and unlock the economic and environmental potential of fisheries worldwide, and EM has a critical role to play in realizing this future.



## About this Report

This paper presents a brief overview of the current state of EM, the benefits of the technology, and the main barriers to broader adoption, as well as a set of recommendations to help catalyze the growth of EM in fisheries. Recommendations are organized around the primary barriers to adoption presented in the paper, and a set of overarching near-term priorities for catalyzing the growth of EM are offered at the end of the report. More than 40 EM experts representing NGOs, foundations, regulators, seafood and catch-sector companies, and EM providers were interviewed as a part of this project, and their perspectives have been invaluable in synthesizing the current state of EM and collating a set of recommendations for advancing the tool. These perspectives have been supplemented with a review of the EM literature. We hope the findings in this report will spur further conversations about the role of EM in improving fisheries management and delivering value to the seafood industry, and help build alignment within the fisheries stakeholder community around how best to advance this tool.

This analysis was commissioned by The Nature Conservancy and prepared in collaboration with California Environmental Associates (CEA). CEA takes accountability for any errors or omissions in this report, and welcomes constructive feedback from readers by email ([electronicmonitoring@ceaconsulting.com](mailto:electronicmonitoring@ceaconsulting.com)).



## Lost at Sea

Fisheries managers face huge challenges in improving the performance of fisheries. They must be able to collect data on the state of a fishery, implement regulations that limit and organize fishing effort and catch, and ensure compliance with those regulations. While managers have a variety of tools at their disposal to collect data and ensure compliance such as logbooks, human observers, dockside monitoring, and at-sea patrols, those tools can be infrequently used, subject to bias and misreporting, and can be expensive or imprecise when they are employed. In many regions, fisheries managers have to make do with poor information and uncertain compliance. They lack the data they need to get the rules of the game right and ensure that everyone is following them. This is often further complicated by managers not trusting or tapping into fisher-reported data and industry not having faith in the science being used to inform regulatory decisions. The end result is huge economic inefficiency—the World Bank estimates losses of \$83 billion worldwide—and a steady decline in the health of fish stocks and the marine environment.<sup>4</sup> With growing human populations, economic development, climate change, and ever-increasing fishing effort, these challenges will only become more daunting in the coming years.

This monitoring and compliance problem is especially acute at sea, where economic incentives can lead to high-grading, illegal transshipments, unreported discards, unreported ETP interactions, and illegal fishing. Without a clear picture of what is happening on the water, managers are forced to use coarse management measures with large uncertainty buffers that erode the economic performance of the industry and can further increase the incentives to ignore regulations. Addressing this challenge requires more targeted management tools that incentivize industry to fish more efficiently and sustainably. But implementing more efficient and effective management measures requires reliable data on the activities of fishing fleets on the water, which we simply do not have for almost all of the world's fisheries.

Until recently, human observers have been the best available option to collect fisheries-independent data and to support management and compliance efforts in fisheries. They set the standard for collecting data at sea, but the reality is that data collected from human observers are often inaccurate due to observer and deployment effects, biased reporting, intimidation and bribery, and the basic human limitations of trying to keep track of all fishing operations in difficult ocean environments. Human observers also cover just a tiny fraction of fishing efforts—likely much less than 1 percent of fishing activity. It is difficult to scale at-sea observers due to the cost and challenges of finding and placing observers in some of the harshest working environments in the world. If we are ever going to get a clearer picture of what is happening on the water, we need additional solutions. It is long past time to bring fisheries monitoring into the 21st century.

The technology to cost-effectively, electronically monitor fisheries has existed for almost twenty years and increasingly is being used to address these challenges. EM is poised to become a norm in fisheries management and will help managers illuminate the dark spots in global fisheries management and create billions in economic upside for fishermen and coastal communities.



## Vision

Every hour of every day, hundreds of thousands of fishing vessels ply the world's oceans. The large majority of these fisheries are managed in the dark, or are not managed at all. Regulators lack accurate information about what is being caught, where, and how. These fisheries are missing the data that is the cornerstone of effective management. As a result, we rely instead on coarse instruments (e.g., days at sea, gear and size limits) or larger buffers to constrain effort and catch to conserve fish stocks.

**EM has the potential to transform global fishing by providing the robust, and verifiable data needed to unlock the economic, environmental, and social benefits of well-managed fisheries. With EM, we can deliver the reliable data needed to sustainably manage fisheries on our shared seas.**

Our shared seas are a public good, and it should be standard practice for them to be fished with the transparency and accountability necessary to ensure they are being fished sustainably. Twenty years of piloting and demonstration projects have established that EM can cost-effectively provide the monitoring capacity and verifiable data that enables sustainable fisheries management. This has been demonstrated in an industry that has yet to achieve any significant scale. The potential of EM is much greater, and we suggest the following three guiding stars for the field:

- 1. Cost-effective accountability for industrial and semi-industrial fisheries.** At the current level of technological development, EM should be available and used as an effective and affordable option for compliance and scientific data collection across many major industrial and semi-industrial fisheries. While there is no uniform definition of what constitutes an industrial or semi-industrial fishery, we define them as fisheries with significant levels of investment and catch value. These fisheries are the ones that are most likely to have significant monitoring needs and the resources to pay for enhanced monitoring. EM systems should continue to be rolled out on these commercial vessels in geographies with reasonable fisheries governance capacity (e.g., the US, the European Union (EU), Canada, Australia, New Zealand, and Regional Fisheries Management Organizations (RFMOs)). Fisheries are a common pool resource and part of a public trust. Cost-effective accountability is a critical component of that trust.
- 2. Robust and timely data for adaptive management.** The real potential of EM will be unlocked when we are able to convert EM data streams into timely, science-based management decisions. Currently, many fisheries remain managed with relatively coarse instruments (e.g., fixed closed seasons, large-scale closures for ETP interactions). EM is capable of providing the more granular information (e.g., species composition, catch per unit effort (CPUE), size distribution, seasonality, ETP interactions, near-real-time information on ETP bycatch hotspots) needed to enable dynamic, adaptive management of fisheries (e.g., when to close a season, when to close a bycatch hotspot, which boats to target). This adaptive capacity is going to be increasingly important in the context of climate change, with shifting stocks and changing ocean conditions. In order to inform more real-time management decisions, future EM systems must be able to transmit processed data to regulators in near real time.
- 3. One-touch verification.** EM should also enable fishermen to instantly collect and verify data needed for reporting and verification, allowing them to demonstrate compliance with the touch of a button. EM ought to be the first step in a fully traceable supply chain—from catch to table—for fisheries. Ultimately, the data from EM needs to be integrated with electronic reporting systems, catch documentation requirements, and supply chain traceability efforts in order to revolutionize seafood transparency.

## Background on EM

### What Is EM?

For the purposes of this report, electronic monitoring includes integrated on-board systems of cameras, gear sensors, video storage, and Global Positioning System (GPS) units, which capture comprehensive video of fishing activity with associated sensor and positional information (Figure 1). The video record is typically stored on a hard drive that is collected at the end of fishing trips and can then be reviewed by an onshore analyst to collect data such as catch volume, bycatch, discards, and fishing location. Some new EM vendors are moving to systems that replace gear sensors with automated analysis of video footage to flag vessel activity of interest, and that use wi-fi, satellite, or cellular networks to transmit data, some in near real time, instead of physically moving hard drives.

Figure 1. Stylized schematic of a trawl vessel outfitted with an EM system<sup>5</sup>

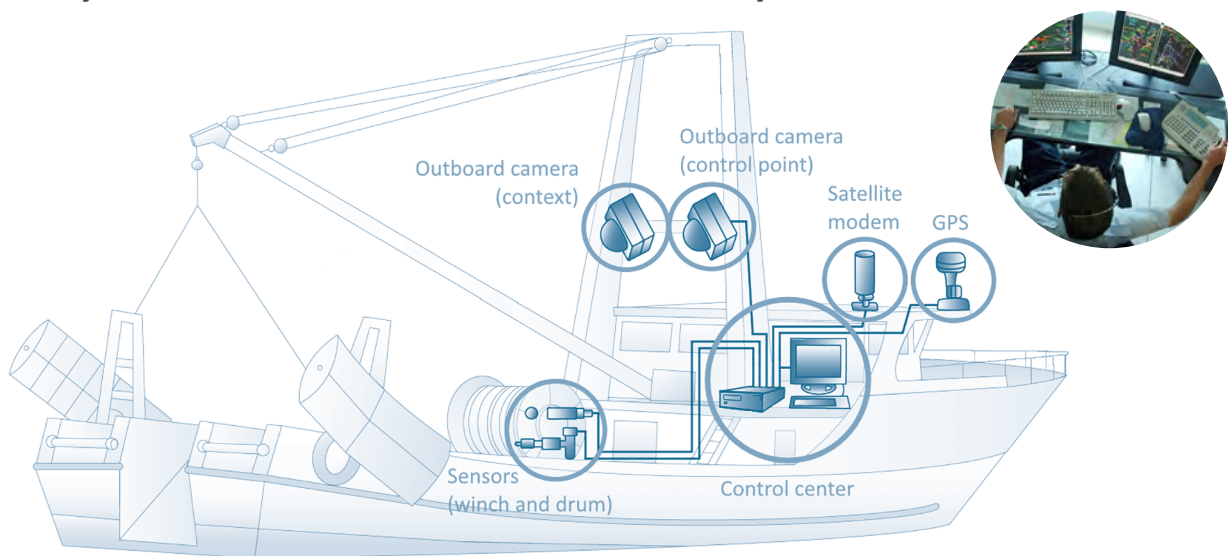

© 2015 Archipelago Marine Research Ltd.

EM can help achieve a variety of objectives, including effort monitoring, catch enumeration, discard monitoring and estimation, assessing protected species interactions, ensuring compliance with bycatch mitigation practices, catch handling verification, monitoring labor practices, and protected area compliance. The EM data can be used to inform fisheries management and ensure compliance with regulations; it can also serve commercial purposes, such as demonstrating sustainability practices or informing business analytics (e.g., identifying bycatch hotspots, analyzing productivity of fishing operations).

EM is one of many monitoring tools for fisheries, but its ability to provide cost-effective and granular data on 100 percent of at-sea fishing activity makes it a game-changer for improving fisheries management and compliance. That being said, it still needs to be integrated thoughtfully within a broader monitoring, control, and surveillance program with complementary tools and on-shore capacity. EM has already demonstrated its ability to cost-effectively transform management and compliance in several fisheries. In its current state of development, EM is well-suited for many of the world's fisheries and its applicability will only expand as the capabilities of EM systems improve and their cost declines. There are fisheries where EM, in its current state of development, may not be an appropriate tool, such as fisheries with minimal on-the-water reporting or compliance challenges, or fisheries with few fishing days or low landed value. In these cases, the costs may currently outweigh the benefits, but EM should be a norm for the world's semi-industrial and industrial fisheries. There is also great need for improved monitoring in smaller-scale fleets, but generally speaking, their vessel earnings will be too low to carry the cost of EM. As costs and technology come down, EM will become viable for a larger share of the world's fisheries.

While EM is a critical tool for providing data on at-sea fishing activities, it is not an end point in and of itself. The true value of EM will only be realized if the data it provides are used to improve fisheries management and compliance, demonstrate environmental and social responsibility claims in the marketplace, or to provide other operational benefits to the fishing industry. Acknowledging the fisheries governance context, careful EM program design, policy and regulatory advocacy, and ongoing dialogue with all stakeholders to refine EM programs are essential elements to ensure that EM leads to meaningful change on the water.

## A Brief History of EM

It has been about two decades since EM was first piloted and implemented in the British Columbia Dungeness crab fishery. A ramp-up in fishing effort had increased competition between fishery participants, and accusations of gear sabotage, theft, and fishermen hauling catch from other fishermen's traps were widespread. To stamp out these problems, the regulator wanted to institute a trap limit for each vessel, but the industry was not interested unless this could be effectively enforced. Faced with these challenges, the crab industry worked with Archipelago Marine Research to develop and pilot an EM program to ensure compliance with these limits and to prevent tampering with other fishermen's traps. The program proved successful in meeting its objectives, and in 2002 license holders voted overwhelmingly to continue the program after a three-year trial period. The program has been fully funded by industry from the start and after several years of demonstrated success the EM program was folded into regulations. More than fifteen years later, the fishery still has an EM program in place,<sup>6</sup> which is now being run by Ecotrust Canada.<sup>7</sup>

Since the first EM trial, use of camera systems has grown slowly, and approximately 1 thousand vessels are now outfitted with the technology. These vessels span roughly 30 different fisheries with about half of the programs in full implementation and the other half in some form of trial or pilot. The figure of 1 thousand vessels represents about 0.25 percent of all the world's fishing vessels over 12m in length,<sup>8</sup> and approximately 3 percent of those vessels in Europe, North America, and Oceania—the three regions where the preponderance of EM systems are deployed.<sup>9</sup> In spite of the promise and proven success of EM in improving fisheries management, progress has been painstakingly slow. The reality is that EM has been a regulatory-driven tool, and regulatory changes in fisheries are often, by design, long processes.

EM, however, appears to be at an inflection point on its adoption curve and is well-positioned for much more rapid uptake in the coming years. A series of policy commitments, expanded pilots, expanded private-sector interest, and entrance of several new EM providers to the market have set the stage for the tool to become a standard practice for monitoring many of the world's commercial fisheries.

<sup>8</sup> 12 meters is used as a cutoff to estimate fishing vessels that are well-suited for EM. Length is being used as a proxy for fisheries with significant landed value and well-developed management systems which are enabling conditions for EM. This is a somewhat arbitrary cutoff, but one for which there is globally reported data.

Below is a brief summary of some of the recent developments in EM.

**UNITED STATES** – After 15 years of trials, EM systems have been implemented or approved in at least seven fisheries. This advancement is underpinned by a growing commitment and focus on electronic technologies from the National Oceanic and Atmospheric Administration (NOAA) and regional fishery management councils. This includes the development of regional electronic technology implementation plans in 2015, which identify priority actions for integrating EM and electronic reporting into fisheries management, and substantial and growing budgetary commitments to electronic technology—approximately \$7 million in 2017, although this allocation is still a small fraction of the roughly \$53 million of federal appropriations for the national observer program.<sup>10</sup> Fisheries that have implemented or are actively exploring EM are listed below.

**Implemented programs**

- Atlantic pelagic longline fishery
- Bering Sea/Aleutian Islands pollock trawl fishery
- Bering Sea/Aleutian Islands non-pollock trawl fishery
- Gulf of Alaska rockfish
- Bering Sea/Aleutian Islands Pacific cod freezer/longline
- Alaska small boat fixed gear fishery
- Alaska pot cod
- Quinault Indian Nation Dungeness Crab Fishery

**In addition, several other fisheries are actively exploring or testing EM, including:**

- Pacific limited-entry Individual Fishing Quota (IFQ) trawl
- Pacific swordfish
- New England groundfish
- Atlantic midwater-trawl herring and mackerel
- Alaska halibut and sablefish IFQ
- Hawaii longline
- Gulf of Mexico shrimp
- South Atlantic snapper grouper
- Gulf of Mexico charter/recreational reef fish
- South Atlantic golden crab

**EUROPE** – The adoption of the Landings Obligation, which requires fishing vessels to land all fish caught at sea, has generated serious discussions about how the regulation will be enforced. To date, much of the fisheries control has happened at landing points and in the supply chain, but the Landings Obligation demands a monitoring solution on the water. Several EM pilots have occurred in Denmark, the United Kingdom, the Netherlands, and Germany, broadly demonstrating the tool's effectiveness in controlling discards, but no program has moved to full implementation. The EU is simultaneously updating the Control Regulation for its fisheries, and the proposed

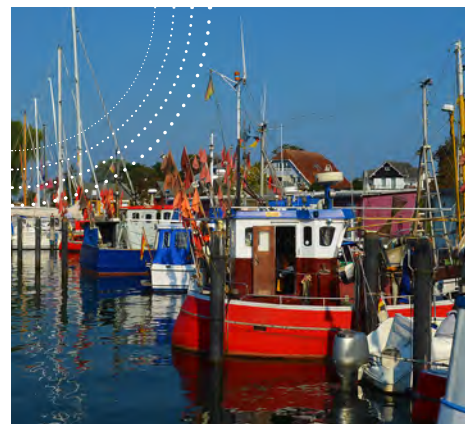



update includes requirements for EM on a percentage of the fleet based on risk to enforce the Landings Obligation.<sup>11</sup> The proposal still needs to work through the legislative process, but this is a noteworthy step toward improved accountability in EU fisheries. Absent the inclusion of EM in the final regulation, there may be other opportunities to push EM forward in Specific Control and Inspection Programmes (SCIPS). Trials of EM in the EU are listed below.<sup>12</sup>

- 2011 Denmark Harbor Porpoise Bycatch Program (9 vessels)
- 2013-2015 Denmark North Sea, Skagerrak, and Baltic Program (14 vessels)
- 2010 Denmark North Sea and Skagerrak Program (23 vessels)
- 2008-2009 Denmark North Sea Program (6 vessels)
- 2015 Southwest England/North Sea Multispecies Program (3 vessels)
- 2015 Southwest England Program (9 vessels)
- 2014 England North Sea Cod (12 vessels)
- 2010-2014 England North Sea Program (6 to 21 vessels)
- 2010 Scotland Cod Program (6 to 27 vessels)
- 2011-2015 Netherlands Cod Program (12 vessels)
- 2011-2014 Germany Baltic Sea Cod Program (2 vessels)

**AUSTRALIA** – Australia’s first EM trials began in 2005 with a single boat fishing in the Southern Ocean. In 2015, EM was adopted for the gillnet hook and trap fishery and the tuna and billfish fisheries. The program now covers 75 vessels and is expected to expand to eventually cover most, if not all, of the Commonwealth fisheries in the next 5 to 10 years.

**NEW ZEALAND** – In 2017, New Zealand passed a regulation requiring EM for all commercial fishing vessels. The initial rollout was slated to begin in October 2018, but the new government has slowed the process. Overall, there are about 20 vessels with EM systems currently installed and a little over 1 thousand additional licensed vessels that could be required to have EM in the coming years,<sup>13</sup> but the timeline and extent of the rollout is still evolving.

**WESTERN AND CENTRAL PACIFIC OCEAN** – There has been a flurry of activity trialing EM in the region over the last few years, primarily on longline vessels. Overall, the longline tuna fishery has a target of 5 percent observer coverage. However, due in part to the difficult working environments on the boats and limited observer supply, the actual coverage has been less than 2 percent. EM offers the potential to increase the coverage of the fleet, and by the end of 2018 there will be approximately 100 vessels with EM systems installed. This number is expected to grow, and there is momentum for EM to be adopted as part of the licensing requirements in several island nations.

**CANADA** – Canada is where the first EM programs were piloted and implemented, but there have been no new EM programs beyond the British Columbia hook-and-line and crab fisheries, which were implemented more than a decade ago. A new EM program, however, is now being considered for the New Brunswick snow crab fishery. The fishery is facing serious restrictions after multiple right whale entanglements with traps, and EM is being explored as a means to better track trap locations and more selectively remove traps that are in high-risk areas for right whale interactions.

**CHILE** – Chile recently made a commitment to install EM systems on its fishing fleets. The country is expected to start with its industrial fleet in the latter half of 2018, and the government is said to have initiated inquiries with all of the major EM providers. Detailed plans for the rollout, however, are not clear at this time.

**INDUSTRIALIZING AND DEVELOPING COUNTRIES** – EM systems have been trialed in several small-scale fisheries, including trials of low-cost EM systems in Indonesia, Mexico, Peru, and throughout other parts of Latin America (e.g., by FlyWire and Shellcatch). There is significant demand for improved data collection in small-scale fishing fleets worldwide.

## The Future of the EM Market

EM is at a critical point in its development and there are a range of future scenarios that may play out over the next decade. For EM to realize its full market potential, we need to build confidence that it can be successfully implemented at scale to meet fisheries management objectives. More work is needed to communicate the benefits of EM, identify new opportunities for the technology, and break down the barriers slowing adoption. Given the uncertainty about EM's future trajectory, we have developed a handful of scenarios to illustrate the potential growth of the EM market and assumptions about what would have to be achieved to realize those scenarios. Each of these scenarios is described below and details of these scenarios are presented in Figure 2 and Appendix A.

**Baseline Scenario** – In the baseline scenario, support for EM continues at its current levels. Costs of EM systems and video review come down, but absent significant growth in the size of the market or support for technological improvements, cost reductions are largely incremental. In this scenario, growth of EM is mostly constrained to fisheries that are already exploring EM in the US, Canada, Australia, New Zealand, Northern Europe, Chile, Peru, and RFMOs. Penetration into the fleets of the main RFMOs reaches just one-quarter of vessels. Under this scenario, ~5,900 vessels are outfitted with EM over the next ten years or approximately 1.5 percent of the world's fishing vessels >12 meters.

**Expanded Growth** – The expanded growth scenario assumes that investment in EM rises significantly from current levels. This increased effort allows for major reductions in the ongoing costs of video review and the commercial application of artificial intelligence (AI) in several key fisheries (e.g., tuna longline). With increased scale and experience, design and implementation of EM programs become more efficient and the EM market becomes more competitive, driving innovation and cost reductions. In this scenario, EM remains largely a regulatory-driven tool, but expanded investment in EM results in increased penetration of EM systems in RFMO fisheries, greater coverage in the Northern EU, US, New Zealand, Chile, and the Peruvian anchoveta fishery. Under this scenario ~11,500 vessels are outfitted with EM over the next ten years or approximately 3 percent of the world's fishing vessels >12 meters.

**New Paradigm** – Under this scenario, EM becomes the tool of choice for monitoring high-value commercial fisheries with acute monitoring demands (e.g., catch quota, discards, ETP interactions, traceability requirements). In addition, private sector benefits of EM (e.g., business analytics, market access) become a major driver of industry demand for EM. Hardware and software advancements have brought the price of EM systems, video review, and data transmission and storage down dramatically. This paired with a well-established understanding of how to design and implement EM programs in different contexts unlocks additional market opportunities for the tool. Performance and interoperability standards are well-established and a highly competitive EM supplier industry has developed. In high governance regions, EM is seamlessly integrated with other electronic systems (e.g., vessel monitoring systems (VMS), electronic reporting, agency back-end systems) to allow for one-touch data reporting. Under this scenario EM achieves widespread penetration in many commercial fisheries that are suitable for EM in high fisheries governance regions (e.g., US, Northern EU, New Zealand), and begins to gain a foothold in more challenging but globally important fisheries regions (e.g., Southern EU, Indonesia, North Asia). Deployment within RFMOs reaches broad coverage rates of 75 percent. Under this scenario, EM reaches ~25 thousand vessels in the next ten years or approximately 6 percent of the world's fishing vessels >12 meters.

**Vision Attained** – This scenario builds from the New Paradigm scenario by extending the reach of EM into additional regions. Countries that have largely relied on input controls to manage their fisheries (e.g., China, Indonesia, Japan, Korea), begin adopting EM as a tool that enables management to transition to output controls such as TACs and catch quota systems. Coverage levels of vessels in these countries remain relatively low (5 percent), but due to the large numbers of vessels, this amounts to thousands of additional

EM systems. Extensive advancements in AI and hardware have reduced costs and made EM applicable for an even larger share of the world's fisheries. This allows for even further penetration into fisheries in the EU, North and Latin America, and enables EM to achieve 100 percent coverage for longline and purse seine vessels in RFMO fisheries. Under this scenario, EM systems are deployed on more than 50 thousand vessels worldwide in the next ten years or approximately 12 percent of the world's fishing vessels >12 meters.

Figure 2. Current and future (2028) scenarios of EM deployment

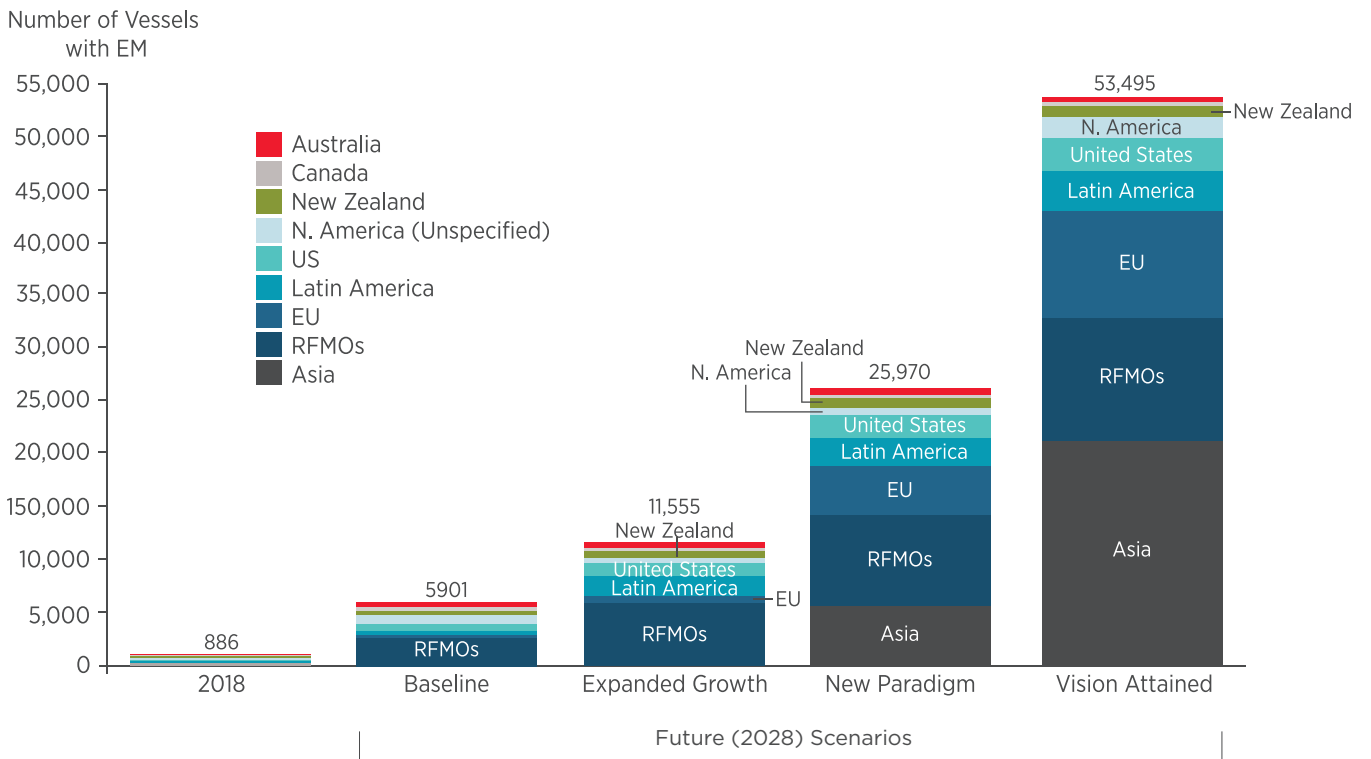
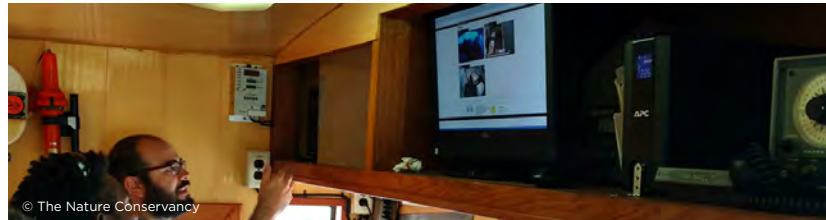
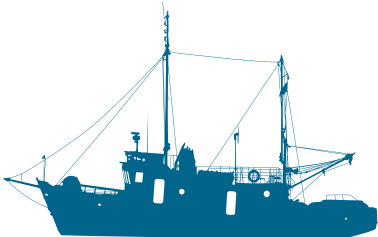

## The Benefits of EM

Almost every early example of EM has involved its application in a fishery where there was a clear management compliance issue (e.g., high-grading, underreporting discards, gear theft, ETP interactions) or where a change in management required increased accountability (e.g., ITQs). In these cases, compliance challenges provided the impetus for better monitoring and justified the initial investment in EM. However, the benefits of EM are significantly greater than just improved compliance. EM provides robust scientific data, enables more real-time management, and ensures that all participants are on a level playing field. In addition, fisheries are starting to demonstrate other ancillary benefits of EM systems. EM can improve on-board operations, validate market claims around sustainability and labor standards, reduce business risk, and empower fishermen by corroborating their on-the-water observations in regulatory and science dialogues.



Relative to human observers, EM programs are typically lower cost, and this advantage will only expand with technology advancements. Although there are some functions for which EM is not well suited (e.g., biological sampling, otolith measurement), the available evidence is that EM can typically improve monitoring coverage, data quality, and compliance relative to human observers for the most important at-sea data needs (e.g., catch volumes). Many of the functions that EM is not currently well-suited for can be moved to the dockside or collected with cooperation from captains and crew.<sup>14</sup> EM can also overcome challenges such as observer and deployment effects; limited pools of skilled observers; low observer coverage rates; bribery, intimidation, or “friendly” observer reports; and basic human limitations (e.g., need to eat, sleep).

### Improving Data Integrity and Compliance

Adoption of EM systems has been primarily driven by compliance concerns on the water, such as gear and catch theft in the British Columbia crab fishery, underreported discards in the British Columbia groundfish fishery, and uncertainty about the scale of sea lion interactions in Australia’s gillnet fishery. Although landing points may be well controlled, data collection at the point of harvest is often a black box and logbook data can be error prone. Moreover, in many fishery management systems, there can be economic incentives for fishermen to ignore rules and misreport activities in logbooks. This means that self-reported data used to inform management and assessments of fish stocks is often inaccurate or skewed. This leaves fisheries managers with an unclear picture of the stock status of fisheries and an inability to set appropriate management measures to maintain the health of fish stocks.

Broadly speaking, fisheries with strong incentives to ignore rules or misreport data include those managed with quotas (particularly those with choke stocks), fisheries with strong restrictions on discards, and fisheries that have penalties associated with bycatch and wildlife interactions. In these circumstances, even if fishermen would like to abide by the regulations, the fact or perception that others are likely ignoring the rules may encourage them to do the same to maintain an economically level playing field. In many of these cases, the obvious way to override incentives to ignore regulations is through improved monitoring at sea. This has been proved in multiple studies, where the adoption of EM resulted in significant changes in behavior and reporting.



In the EU, fisheries are managed with a combination of quotas, effort restrictions, and landing obligations. This structure, in tandem with limited monitoring at sea, has created a strong incentive for fishermen to discard fish for which they have limited quota or smaller fish with lower market value. From 2010 to 2012, EM systems were tested in Denmark to determine whether they could obtain accurate catch data in support of a catch quota management system and paint a clearer picture of what fishermen were actually catching, as opposed to what they were bringing to shore.<sup>15</sup> A similar trial occurred in the United Kingdom from 2012 to 2015.<sup>16</sup> In both of these trials, vessels equipped with EM were found to land a significantly higher share of the smallest size cod grade than vessels that did not have EM (Figure 3). According to the author of a review of the Danish trials, “it can be concluded that high-grading takes place if fishing was not fully monitored and documented.”<sup>17</sup>

Figure 3. Percentage of cod landings that are grade 5 (smallest) in UK and Danish fisheries with EM trials

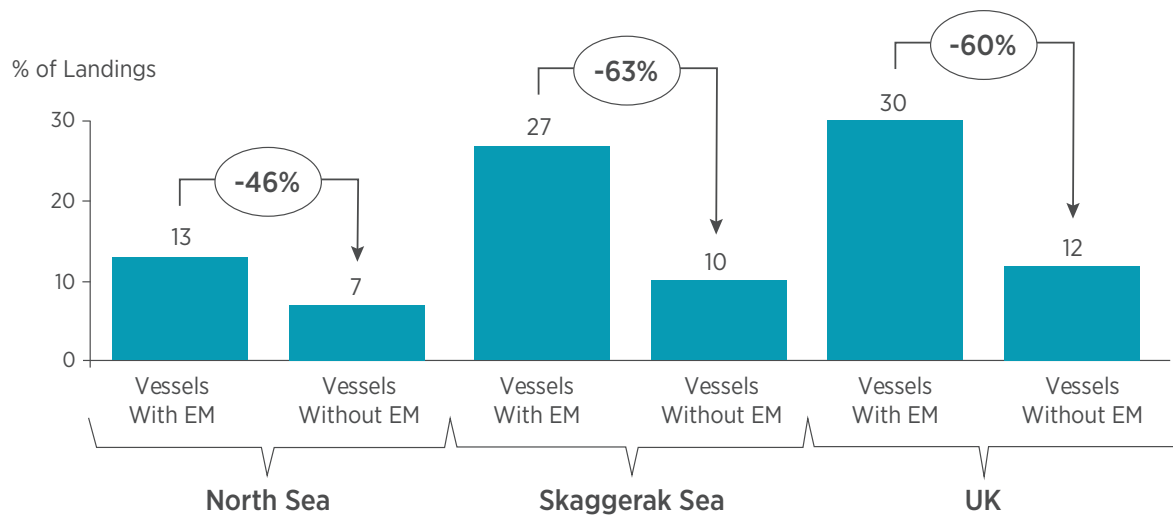

Similarly, reported discards in Australia’s longline fisheries more than doubled after the installation of EM in 2015 while overall reported catch remained the same (Figure 4). The increased logbook reporting was most pronounced for seabird and mammal interactions, which both increased seven-fold. The conclusion was that “this appears to be quite unambiguously associated with the introduction of EM.”<sup>18</sup>

Figure 4. Comparison of reported landings, discards, and number of different species caught pre- and post-EM in Australia

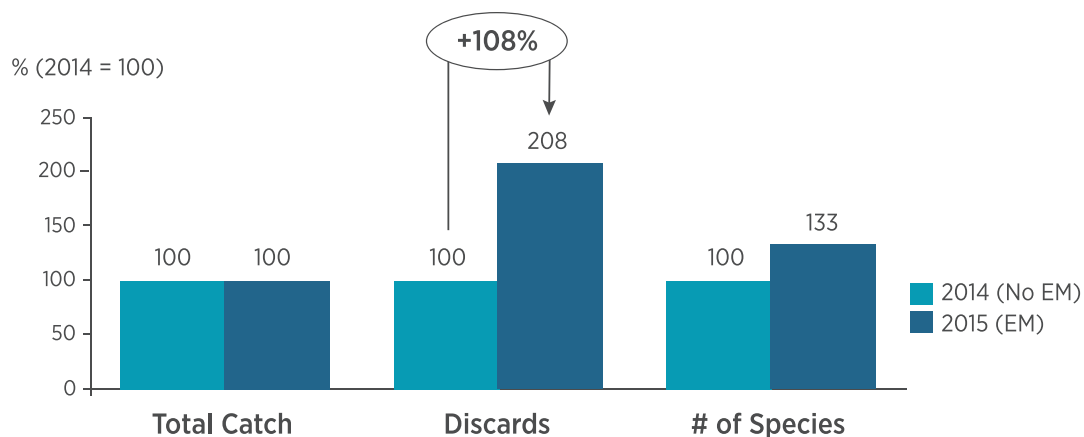

These studies demonstrate how, without comprehensive monitoring and accountability at sea, some fisheries face systematically ignored regulations and misreported catch. As one regulator commented, “I’ve always said that there are certain fisheries that you cannot operate without 100 percent coverage; the incentives are

just too strong to misreport.”<sup>19</sup> (See Box 1) The end result is often overfishing and fisheries that fail to meet their economic and environmental objectives. Consequently, managers can be required to apply coarse or draconian management measures to try and steer the fishery back on course. While human observers could have achieved similar compliance outcomes in these examples, EM offers numerous benefits relative to at-sea observers, including cost and reduced risk of corruption. These relative advantages are discussed in more detail throughout the remainder of this paper.

These case studies are not unique. Most of the world’s fisheries face similar on-the-water data and compliance challenges. In the Pacific Islands, which is the world’s most important tuna fishing region, IUU fishing is believed to account for \$600 million in tuna catch each year. A combination of unlicensed fishing, misreporting, non-compliance with license conditions (i.e., illegal fish aggregating device fishing (FAD)), and post-harvest risks (e.g., transshipment) comprise this astounding level of IUU fishing. A common misconception is that unlicensed or “dark” vessels are responsible for the bulk of this illegal fishing, but in fact more than 95 percent of IUU tuna fishing in the region is executed by the licensed fleet. This means that there is a huge opportunity to solve the IUU challenge in this fishery by improving monitoring, control, and surveillance of licensed fishing vessels. The study characterizing the scale of IUU in Pacific Island tuna fisheries identified EM as a tool that would be “highly effective” at addressing the IUU risks in the fishery.<sup>20</sup> With roughly 2,700 tuna vessels fishing in the region,<sup>21</sup> an EM program could be implemented for the entire Western and Central Pacific Fisheries Commission (WCPFC) tuna fleet at an annual cost of roughly \$30 million,<sup>22</sup> far less than the \$150 million in lost economic rent for coastal states due to IUU.<sup>23</sup> EM would also likely be more effective at controlling IUU and lower cost than other compliance mechanisms, such as at-sea patrols.



<sup>22</sup> Assumes an amortized cost of 10K per vessel.



## The Codfather

The New England groundfish fishery provides a cautionary tale of what can happen with an incomplete monitoring system. This multispecies fishery is managed with annual catch limits for more than twenty different species, but at-sea monitoring covers just 15 percent of groundfish sector trips in 2018,<sup>24</sup> and there is no dockside monitoring. With limited catch entitlements, especially for cod, the lack of comprehensive monitoring incentivizes discarding and misreporting. This leaves fisheries managers without an accurate picture of what is happening on the water, which in turn undercuts their ability to set and enforce annual catch limits that will support the long-term economic and environmental health of the fishery.

The now-infamous case of the “Codfather,” the moniker for New Bedford fishing magnate Carlos Rafael, is an astounding case in point about the ability of even one unmonitored actor to disrupt the integrity of an entire management system. Rafael, the owner of Carlos Seafood—one of the largest commercial fishing companies in the US—was charged by federal investigators with misreporting approximately 780 thousand pounds of fish.<sup>25</sup> Rafael followed an illegal practice of claiming catch as haddock or another abundant species when it was in fact quota-restricted cod or sole. Due to these falsified catch reports, NOAA placed a ban on an entire sector in November 2017.<sup>26</sup> According to John Bullard, former Regional Administrator for NOAA Fisheries Greater Atlantic Region, fishermen associated with Rafael’s company exceeded quotas of cod, yellowtail flounder, and witch flounder by potentially as much as an entire year’s quota.<sup>27</sup> Rafael’s activities distorted both the market for the region’s fisheries and scientific assessments of the fisheries’ health.

For the New England groundfish fishery, inadequate catch data has been the fishery’s “Achilles heel,”<sup>28</sup> particularly for cod, which are at a historic low of 80 percent less than the population ten years ago.<sup>29</sup> Bullard and others have proposed using EM as a cost-effective method for expanding and improving monitoring and accountability. “With a large portion of the fishery going unobserved and recognizing that fishing behavior may be different on unobserved trips, we may be missing out on a lot of critical information. EM could gather data from all trips, which is a quantum leap in the amount of information available to scientists. This could result in better science and potentially lower uncertainty when setting quotas. So, while at-sea monitoring is a cost, EM could be an investment.”<sup>30</sup> To highlight the cost-effectiveness of EM, Bullard stated, “We can monitor 100 percent of the fishery for roughly the same amount of money it takes to monitor 20 percent of the fishery with the current observer-only program.”<sup>31</sup>

## Enabling Incentive-Based Management

The main benefit of fuller accountability is that it allows regulators to adopt more targeted and efficient management measures. Improved scientific data and confidence in compliance on the water allows managers to employ tools such as individual quotas rather than effort limits to increase the economic performance of the fishery. As one regulator said, “having a bureaucrat in an office is not the best way to tell you how to fish.”<sup>32</sup> The World Bank estimates that inefficient fisheries management results in \$83 billion in annual economic losses compared to a scenario where all fisheries were managed economically efficiently. Case studies abound of overcapacity, overfishing, and misaligned incentives in fisheries that result in reduced economic and environmental performance of fisheries. The collapse of the Northwest Atlantic cod fishery is an iconic example of the cost of mismanaged fisheries. But, almost all fisheries have opportunities to improve management, many of them dramatically so, and EM can help deliver the reliable data needed to unlock this efficiency.

For example, in the US Atlantic, the highly migratory species longline fishery has faced challenges with bycatch of overfished bluefin tuna. Historically, bluefin bycatch was managed with a combination of fleetwide limits and area closures, but accurate accounting of bluefin catch has been a struggle. In 2014 and 2015, the fishery simultaneously rolled out an individual bluefin quota (IBQ) system and 100 percent EM for the fleet to improve tuna bycatch management and accountability. The allure of increased flexibility under a quota system helped bring the fishing fleet to the table to consider comprehensive monitoring of the fishery, and the relatively high cost of human observers ultimately steered the fleet toward EM. Under the IBQ, vessels in the fishery have strong incentives to reduce their bluefin tuna bycatch to stay within their quota limits. Additionally, EM data is helping managers perform retrospective analyses of previously implemented management tools, such as closed areas. As more confidence is gained in the EM and IBQ programs, there is hope that some of these broad restrictions (e.g., closed areas) can be scaled back, further increasing the flexibility of the fleet.<sup>33</sup>

In Australia, the granularity of data from EM systems has allowed managers to identify specific boats with high levels of bycatch, thereby allowing them to sanction individual vessels rather than implement large-scale closures for the whole fishery. For example, in the Commonwealth gillnet shark fishery, dolphin mortalities previously forced the management authority to implement fishery-wide area closures. But now, with EM, managers can exclude individual boats or operators if they exceed the prescribed dolphin mortality rate within a six-month period. Similarly, in the tuna longline fishery, managers used to close five-degree latitude bands for the entire fishery if the seabird mortality rate exceeded 0.05 birds per 1 thousand hooks. Using EM, managers can specifically target boats that have high rates of seabird catch, requiring them to use additional mitigation methods. The result is that managers are able to focus on the small portion of the fleet with the most challenges, while maintaining flexibility for the remainder of the fleet.<sup>34</sup> At the same time, it creates a strong incentive for individual vessels to avoid bycatch.

Perhaps the most striking example of full accountability delivering increased flexibility to fishermen is in the US West Coast groundfish fishery. The successful transition of this fishery from a trip limit scheme to an IFQ was enabled by a 100 percent monitoring requirement. While this requirement has been achieved primarily through at-sea observers to date, the fishery is rapidly moving to EM as a more cost-effective mechanism to meet this monitoring requirement. Under output controls, the fishery has doubled net revenues, seen fishermen take advantage of the flexibility of the new management system, and dramatically reduced the catch of overfished species.<sup>35</sup>

Prior to the implementation of the IFQ, a series of large-scale closed areas called Rockfish Conservation Areas (RCAs) were designated along the entire West Coast to protect overfished species. These closed areas have long been a source of frustration for the fishing industry, but with 100 percent accountability in the fishery, discussions about scaling back these protected areas progressed. With full accountability and



catch limits in place for the key species in the fishery, there was less of a need to use large-scale closed areas as a means to protect overfished species. After long deliberations, the Pacific Fishery Management Council took final action in April 2018 to reopen the groundfish trawl RCAs in Oregon and California to bottom trawling, and to modify the current configuration of Essential Fish Habitat Conservation Areas where groundfish bottom trawl gear is prohibited coastwide.<sup>36</sup> Trawl fishermen will now have more flexibility to fish where they would like and make their own decisions about how best to stay within their catch limits for rockfish species.

## Building Shared Trust in Fisheries-Dependent Data

With limited at-sea monitoring, a schism of mistrust can form between fishermen and management. Managers don't necessarily trust what fishermen report in their logbooks, and fishermen do not necessarily trust the science delivered by managers. Nowhere is this paradigm more evident than in New England, where perspectives on the health of cod stocks could not be more divergent. As one New England fisher succinctly said, "we look at the scientists and say, 'you're full of shit,' and they look at us and say the same thing."<sup>37</sup>

The official 2017 stock assessment estimated the Gulf of Maine Atlantic cod stock at just 5-8 percent of optimal levels.<sup>38</sup> According to a NOAA scientist, "We are seeing an overall downward trend since we have been able to



achieve population estimates directly from the stocks beginning in the 1980s . . . we are seeing numbers that were about 40 thousand metric tons back then and now we are seeing about 4 thousand metric tons."<sup>39</sup> Many fishermen, however, believe that the science is flawed and that there is so much cod in the water they cannot avoid it. As one fisher said, "Since around 2001, the cod stock has been in better state than we have ever seen it in our lives . . . The divide between what I see in the water and what I get for quota couldn't be more polar opposites than what I've seen for the 30 years I've been on the water."<sup>40</sup> The divergence in perceptions is exacerbated when fishermen do not have the quota to land the cod they encounter and therefore discard it at sea without reporting it.

EM can pull stakeholders out of their respective corners by transforming what is often considered anecdotal fisheries knowledge into trusted data. As one fisher said, "When I show up to a regulatory meeting or a hearing, I can say, 'Here's what I'm seeing on the water and here is my evidence to prove it.'" <sup>41</sup> Another echoed a similar sentiment: "Without the camera, my information is viewed as anecdotal to fisheries managers, but a camera makes my observations more substantive . . . EM gives fishermen power."<sup>42</sup> The shared trust in data has the potential to change the tenor of fisheries management conversations from a highly politicized resource access fight to a more collaborative resource health and productivity discussion.

A similar refrain can be heard in British Columbia's hook-and-line groundfish fishery. In this fishery, EM video is audited at a 10 percent rate to validate fishermen's logbooks, which are the primary sources of catch data. Participants in the fishery report that using their logbook records gives them a greater sense of ownership in the program while also increasing their willingness to work through the practical challenges of the program and to cope with regulatory changes.

## Operational Benefits of EM

In longline tuna fisheries in the Western Central Pacific, several companies have voluntarily installed EM systems on their vessels in the absence of regulatory pressure for their internal operations management. According to one of the participating company representatives, “We installed our own EM systems because we wanted to keep track of our operations at sea.” The EM systems provide assurance that the companies’ vessels are fishing in compliance with regulations and company policies and allow monitoring of catch composition and fish handling practices, baiting procedures, and health and safety practices, as well as enabling companies to guard against product shrinkage. In the longline tuna industry, product quality is a key differentiator, and EM allows companies to adjust product handling workflows to maximize the quality and value of their catch. You cannot manage what you cannot see, and EM brings increased visibility to what happens onboard fishing vessels hundreds of miles from shore.

More generally, captains can benefit from the multiple camera views available to them at the helm. This enables them to quickly assess what is happening at different parts of their vessel and fine tune their operations. From a safety perspective, being able to monitor all parts of the vessel from the helm is also a huge benefit for captains.

One area of future opportunity is that data from EM (e.g., catch, vessel, location, CPUE) can underpin business analytics solutions that can increase fishery value. The idea is that EM data can be processed and aggregated to provide valuable information to fishermen. In Alaska, for example, the Pollock Conservation Cooperative partners with a private sector company, Sea State, to analyze fishing data and identify bycatch hotspot areas for the fleet to avoid.<sup>43</sup> Similarly, The Nature Conservancy has developed an app to collect catch data that can identify bycatch hotspots for US West Coast groundfish fishermen. Fishermen who upload data can then access aggregated data from other fishermen and use the information to help them avoid bycatch of choke species in the fishery.

In the Western Pacific, a tuna company is taking a broader approach to mining its data and is now partnering with Chinese researchers to pair EM data with oceanographic information to generate business insights for its fishing operations. EM could be particularly valuable for companies that own multiple fishing vessels; the data could yield insights about which vessels are most efficient and why.

## Seafood Market Benefits from EM

While EM has primarily been a regulatory-driven tool, there is growing interest in the potential market benefits that EM can provide the fishing and seafood industry. Demonstration and broader understanding of how market benefits could be achieved with EM should build demand and overcome resistance to the tool. Broadly speaking, these benefits are largely undeveloped and much work is needed to solidify these opportunities. Seafood supply chain companies have made commitments to sourcing and supplying sustainable seafood, yet many fisheries lack strong incentives for sustainable practices that deliver meaningful change on the water. EM can be a tool that enables stronger supply chain pressure and can actually validate good practices on the water. Below we outline a few of the areas where EM could provide market benefits.

### Eco-Certification and Verification of Sustainability Claims

The past decade has seen incredible growth in the sustainable seafood movement. Almost all the largest retailers and foodservice providers (e.g., Sodexo) in the US and Europe now have commitments to source sustainably certified seafood or seafood from fishery improvement projects (FIPs). Fourteen percent of the world’s marine landings comes from fisheries that are Marine Stewardship Council (MSC)-certified or undergoing full assessment against the MSC standard.<sup>44</sup> An additional 9 percent is from fisheries in FIPs. Sustainability demands on fisheries continue to ratchet up, and EM can validate compliance with buyer

requirements (e.g., legality) and can also be a tool to support eco-certifications or sustainability claims (e.g., FAD-free). While demand for fish caught specifically with EM is still emerging, a handful of companies have already been able to leverage their use of EM to access some niche, premium markets. More broadly, EM can also help fisheries that are looking to achieve eco-certification. For example, cameras onboard vessels offer a higher degree of verification and lower bias than some other monitoring approaches, which can increase MSC assessment scores.<sup>45</sup>

## Traceability

Traceability in seafood supply chains has received increasing attention over the past several years. Concerns about IUU fishing, mislabeled fish, slave labor (See Box 2), and food safety have pushed traceability to enhance visibility of every step in the seafood supply chain to ensure legality and that it was handled safely. With serious environmental and social problems embedded in the supply chain, seafood companies have made sustainability commitments and claims. These claims, however, have not been matched with commensurate transparency and accountability throughout the entire supply chain, especially on the water, leaving these companies vulnerable to risk. Speaking about the challenges of slave labor in Thailand, Thai Union's sustainability director said, "Companies might say they'll just source from another country that has no slavery in their supply chain, but I'd like to know what that country is. This is an issue that occurs across the fishing industry worldwide."<sup>46</sup>

Following suit, retailers are exerting more and more pressure on their suppliers to implement traceability systems, primarily as a risk mitigation tool to make sure that activities in the supply chain are aligned with company commitments. But traceability systems are only as good as the data fed into them, and there is a huge gap in these efforts in that there is no monitoring of what is happening at sea before seafood enters traceability systems at the dock. One can trace the fish from dock to consumer, but still not be certain about the legality or sustainability of the product nor the labor conditions on board the vessel that caught the fish. As one industry representative said, "We need to connect EM with traceability initiatives. Everything is dock to plate; let's make it hook or net to plate."<sup>47</sup> A growing number of seafood retailers are differentiating themselves based on their traceability credentials<sup>48</sup> and linking EM with traceability systems will allow for complete and transparent net-to-plate origin stories.







## Monitoring Labor Conditions

Slavery and poor labor practices have long been embedded in the fisheries catch sector, and the last few years have finally brought more attention to these abhorrent practices. A series of investigations and exposés have brought to light issues such as inhumane work schedules, gross underpayment or forced labor, confiscation of documents, lack of decent food and clean water, unsanitary and unsafe working conditions, physical and verbal abuse, lack of medical care, and even murder at sea.<sup>49, 50, 51</sup> Given the general environment of lawlessness, poor regulation, and lack of control and enforcement at sea, some operators resort to these labor abuses to maintain the viability of their fishing operations. This problem is only exacerbated by overharvesting of fish stocks, which forces vessels to go further afield and on longer trips in search of fish, putting even more pressure on the economics of the catch sector.<sup>52</sup>

Seafood products harvested using slave or inhumane labor practices end up in the supply chains of multinational seafood companies, restaurants, and retailers worldwide including those in the US and EU. Several companies have acknowledged the presence of slave labor in their supply chains, such as Nestle and Thai Union,<sup>53</sup> and many more have been linked to inhumane labor practices through investigative reports.<sup>54</sup> This has been an embarrassment for these companies, reduced their goodwill, and highlighted the risk that is embedded in global seafood supply chains. Companies are scrambling to find solutions but ferreting out poor labor practices has proven to be exceedingly difficult. The global nature of seafood supply chains means that major retail and food service companies will source products from high-risk regions. This combined with complex, murky supply chains and a complete absence of on-the-water transparency mean that it is all but impossible to verify good labor practices across their entire seafood supply chains.

EM, however, can help solve this problem. While the tool has not been widely applied to address labor issues it is well-suited to the task. Already, vertically integrated companies have used their own onboard camera systems to assess labor practices. EM vendors have also stated that their systems can be used to monitor safety practices, working conditions, and social interactions validating good on-board practices.<sup>55</sup> Bringing greater transparency to at-sea operations is the only way to be confident that fishing crews are treated humanely and operate under safe working conditions. Thai Union's recent commitment to have 100 percent EM or observer coverage on all of the longline vessels it sources from is an acknowledgement of this fact.<sup>56</sup> The challenge now is to make this commitment to at-sea accountability a reality worldwide and to put an end to inhumane and unsafe conditions on the seas.



### **Verification of Compliance with International Trade Standards**

Recently adopted import standards in the EU and the US are placing pressure on countries to provide documentation that their exported products have been legally caught. Similarly, the Commission for the Conservation of Antarctic Marine Living Resources (CCAMLR) has a catch documentation scheme for toothfish that requires importing countries to verify the source and legality of all toothfish entering their territory.<sup>57</sup> EM ought to be a critical tool for bringing transparency and assurance that imported fish were legally caught and have accurate and verifiable catch documentation. Likewise, seafood products entering the US will soon have to demonstrate a regulatory program comparable in effectiveness to the US regulatory program to mitigate impacts on marine mammals.<sup>58</sup> EM can prove the effectiveness of marine mammal bycatch mitigation measures and potentially ensure the performance required to access the US seafood market. Measures such as the EU carding system have placed pressure on countries to crack down on IUU, but more can be done to ensure that these measures lead to meaningful changes in fishing practices. EM can make much more granular data available on fisheries, which can play a role in ratcheting up the requirements of international trade standards and ensure that the standards actually deliver on the intended results on the water.

### **Insurance**

In the future, another potential benefit of EM may be to enable reductions in marine insurance costs. EM can facilitate rapid accident investigations, claims processing, and liability reduction, and perhaps in the longer term could allow fishermen to demonstrate lower risk to reduce premiums (e.g., akin to opt-in auto insurance trackers). Interestingly, requests for access to EM video from vessel owners comes more often from issues like an injury on a boat than regular fisheries monitoring,<sup>59</sup> indicating the potential value of these systems in quickly processing insurance claims. The fishing vessel insurance market remains relatively niche, but the cooperative fisheries insurance market may be an excellent avenue to start trying to integrate EM into policies.

## Benefits of EM Compared to Human Observers

For many core functions, such as monitoring for discard events, logbook auditing, and catch accounting, EM can deliver more comprehensive and higher-quality data than human observers at a lower cost. Human observers, however, are still better suited to collecting some data, such as biological samples and species level identification of bycatch and discards. For some of these data, EM can be used effectively with specific on-board handling procedures, for example sorting and presenting discards to a camera. But, for other data, such as biological sampling, human sampling is still the preferred approach. That being said, EM is more scalable, typically covers a much larger share of fishing activity, and the data from EM programs is not as susceptible to bias, bribery, or intimidation. Vessel captains and crew also typically appreciate not having the burden and responsibility of having an at-sea observer on board their vessel. These benefits are described below.

### Scalability

The single largest problem with human observer systems is that there simply is not and will never be enough coverage. Human observers currently monitor a very small fraction of global fishing effort (i.e., less than 1 percent) and are unlikely to scale much beyond current coverage levels. As one regulator said, “What human observers [programs] lack is an ability to cover a large portion of fishing operations.” Very few fisheries have the supply of skilled and willing observers available to enable comprehensive at-sea monitoring. More importantly, small vessels, remote locations, long trips at sea, and harsh work environments can make it difficult to meet demand. As one stakeholder in the Pacific longline fishery said, “Observer coverage is in the range of 1-2 percent for the longline fleet, below the 5 percent objective<sup>60</sup> . . . The vessels we buy from are small and simply don’t have the space for an extra person. The crew quarters are tight, and the observers mandated to conduct observer duties hate to do it. It is that difficult.”<sup>61</sup>



Efforts to ramp up the supply of observers can have the unintended consequence of reducing their quality. As one New England fisher said, “When the groundfish fishery transitioned from days-at-sea to catch share management, the rate of observed trips increased and the quality of observers decreased.”<sup>62</sup>

Unlike humans, EM systems are always available. If a fisher would like to go fishing, he does not have to coordinate the availability of an observer, which can be a major challenge anywhere but especially in remote ports. Even where these issues can be overcome, the cost of using humans can be untenable in some fisheries. In Australia, for example, regulators moved to 100 percent monitoring in response to sea lion bycatch in their gillnet fisheries, but quickly realized that the \$1,100/day cost of an observer was going to “end fishing.” There are many cases like this, where a fishery demands comprehensive monitoring but the economics of the fishery, or specific classes of vessels within the fishery, cannot shoulder the cost of human observers. In many of these cases EM is a viable solution, and as the cost of EM systems continues to decline it will be an option for an increasing share of the world’s fisheries.

Once EM systems are installed, it is also easy to increase the rate of review if there is a need for more comprehensive data.

<sup>60</sup> There is debate about what a sufficient level of observer coverage is for the fleet with most arguing that 5 percent is too low. A large majority of experts are coalescing around 20 percent coverage as a minimum assuming the coverage is well-distributed.

## Eliminating Deployment and Observer Effects

In most fisheries with at-sea observer programs, coverage is far below 100 percent, which leaves data collection systems vulnerable to deployment and observer effects.

Deployment effects occur when the allocation of observers on fishing trips does not capture a representative sample of the entire fishing fleet. This can be due to a variety of issues, such as the types of vessels that are amenable to on-board observers and the location of the fishing fleet relative to the available observer pool. Although theoretically easy to manage, the realities of matching observers to fishing trips can make deployment effects difficult to avoid. For example, a 2009 NOAA assessment found that in Alaskan groundfish fisheries, seven out of nine fisheries had observer coverage that deviated from the required ratio for observed trips to be representative of the fishery.<sup>63</sup>

Observer effects result when fishing activity on observed trips deviates from activity on unobserved trips. If fishermen are worried about issues such as catching choke species or ETP interactions, they may change the location, method, or duration of a trip to minimize these challenges while being observed. In a 2010 survey of fishermen in the Gulf of Mexico and Northeast US, 68 percent of fishermen agreed that the presence of observers affected their fishery practices in ways that reduce violations.<sup>64</sup> The end result is that data collected by observers is not truly representative of the entire fishery.

Recent research in the New England groundfish fishery has also found evidence of observer effects. Looking at data from 2007 to 2017, NOAA found that trawl vessels on observed trips fished for a shorter duration, caught less, had higher average price of groundfish, and kept less groundfish. These differences imply that the composition of catch on observed trips is fundamentally different than the composition on unobserved trips.<sup>65</sup> There are multiple potential reasons for these differences, but they are likely due to discarding of choke species on unobserved trips.

In the world's most important tuna fishing region, there is also evidence of observer or deployment effects. Fishermen in Palau's pelagic longline fishery made 33 percent shorter trips when the government assigned an observer to their vessel, which indicates that observed fishing activity is not representative of the entire fishery.<sup>66</sup>

With most EM programs, video footage can be recorded for 100 percent of fishing activity. Even if only a fraction of the footage is ultimately reviewed, fishermen do not know what portion of the trips will be subject to review, mitigating the incentive to fish differently when being watched. Similarly, if EM systems are installed across an entire fleet, it can eliminate many of the logistical challenges of observing a representative sample of fishing activity, thereby avoiding deployment effects.

## Mitigating Human Challenges

Even on trips with human observers, or in fisheries with 100 percent human observer coverage, obtaining accurate and comprehensive data is not guaranteed. Human observers need to take breaks, get sick, eat, and sleep, but cannot push the pause button on the fishing operation. Moreover, unlike EM systems with multiple camera views, it is impossible for a human observer to see everything that is happening on deck.

In the worst cases, fishery observers have been subject to intimidation, harassment, interference, bribery, and even violence in the name of falsifying observer reports. Far from shore there is little protection for observers from intimidation by captains and crew. This problem may be more common on the high seas and in the developing world, but observer intimidation has been documented in the US and Europe as well. A survey of NOAA observers in the US found that 7 percent of observers had been pressured to change data, 15 percent experienced interference or biasing of samples, and 13 percent had faced tampering or destruction of their equipment or records.<sup>67</sup> NOAA also recently closed a case against a vessel in Alaska including "four counts of harassing observers, having the purpose or effect of interfering with the observers'

work performance, or otherwise creating an intimidating, hostile or offensive environment.”<sup>68</sup> Foul play was also not ruled out in the recent death of a NOAA observer.<sup>69</sup> Similarly, an exposé in the EU in 2012 found that many EU observers had experienced harassment while fulfilling their oversight duties.<sup>70</sup>

Even without threats, individual incentives can naturally result in inaccurate reporting. Observers may live in the same communities as fishermen or may have multiple trips with the same vessel. This can incentivize favorable reporting in the name of improving the working or personal relationship with vessel crew. In some fisheries, observers may also have incentives to underreport catch to extend the length of the season and increase the amount of work available to themselves.<sup>71</sup>

While EM does not eliminate all of these challenges, it makes data collection less susceptible to coercion. The separation of EM analysts from fishing operations minimizes the likelihood that they will be subject to intimidation or bribery, or that they will submit favorable reports to curry favor with vessel captains and crew. With EM, multiple camera views and the ability to re-watch events or bring in others for consultation can improve the accuracy and interpretation of fishing events.

## On-Board Benefits for Captain and Crew

Captains and fishermen who install EM systems often appreciate not bearing the responsibility of having observers on board. As one New England fisher said, “I fish primarily on boats less than 50 feet and space is at a premium . . . One thing that was not understood is the amount of stress that an observer puts on the operator in December when I am looking at a forecast that is unfavorable. It’s a person on my boat that is ultimately my responsibility, no matter how much insurance I’ve got. It weighs on us, heavily.”<sup>72</sup> At a more basic level, not having an observer makes the vessel more comfortable for captain and crew. Describing the benefits of having an EM system, Lisa Damrosch of Half Moon Bay Seafood said, “These are a lot of small boats, so not having an observer meant it was the first time my brother had a bed since 2010 on a trip.”<sup>73</sup>



## Data Quality

A critical question for EM is how the quality of data from cameras and sensors compares with other forms of data collection. Numerous studies have compared EM data with data from self-reported logbooks and at-sea observers. Broadly speaking, EM can effectively monitor for discard events, and has proven to be at least as accurate as other methods at estimating the catch of target species in serial fisheries. It has also shown the potential to be accurate at identifying bycatch of ETP, such as turtles, seabirds, and sharks, although EM can be challenged by interactions that happen outside the field of view or for species that are released without bringing them onboard (e.g., cutting a branch line). This challenge has been addressed in at least one fishery by implementing catch handling requirements to bring hooked or entangled species as close as possible to the vessel although it is still difficult to differentiate between similar looking species with EM (e.g., dusky and bronze whalers). For data on catch and discards of non-target fish species, there is more variation between EM and observer-reported data. This can be due to a number of reasons, including small sample sizes, difficulty in identifying non-target species, and more procedural support required from fishermen on board to obtain good footage to make accurate bycatch and discard estimations.



EM has also been proposed for a variety of other objectives, such as monitoring transshipments, catch estimation for purse seine fisheries, labor standard compliance, and waste management procedures. While it is likely that EM can be an effective tool for these functions, there has been limited published testing of these applications to date. As the technology improves and experience with EM systems grows, the quality of data from EM is also expected to improve. Data from human observer programs, which are much more mature and established than EM, will always be constrained by limitations of humans on-board fishing vessels and are unlikely to improve significantly in the future.



Generally speaking, data collected from EM is more closely aligned with observer or logbook data in serial fisheries (e.g., trap, longline, gillnet) versus higher-volume fisheries (e.g., trawl, purse seine).<sup>74</sup> That being said, EM has been shown to be capable of discard estimation in multispecies trawl fisheries, if appropriate catch handling procedures are followed.<sup>75</sup> This typically requires on-deck sorting and presentation of discarded species to the camera. In many studies, the alignment of EM data with other data sources improved after a handful of trips with troubleshooting and refining of on-board handling procedures, hardware adjustments, and increasing familiarity and skill of video reviewers.<sup>76</sup> This emphasizes the need for feedback between EM reviewers and vessel crews to make sure on-board procedures facilitate video review and accurate data collection. It also illustrates that EM programs need to have broad buy-in from harvesters, and be structured to incentivize captains and crew to consistently follow agreed-upon procedures to be successful. A summary of studies comparing data collected with EM versus human observers or logbooks can be found in Appendix C.

It is important to note that in studies comparing EM to logbooks or human observers, the participants (observers, captain, and crew) knew that their reported data would be compared against EM data and it is reasonable to assume that this incentivized more careful practices. Huge changes in reported catch and discards in fisher logbooks after installing EM systems indicate that the presence of video can change reporting behavior and reduce or eliminate observer effects, since EM systems are on 24 hours a day. As one fisheries manager said about installing EM on vessels, “You could turn the power on and not collect anything and completely change behavior.”<sup>77</sup>

EM, however, is not the best solution for all fishery data needs. In addition to the limitations discussed above, other data, such as biological sampling (e.g., otoliths, sexes, and maturity) are better suited for at-sea observers or dockside monitoring programs. While developments in EM technology will expand the capabilities of EM systems, there will continue to be a role for human observers – either on board or dockside – in some fisheries. For example, a study of data collection in Pacific longline fisheries found that there were 101 observer data fields that could not be collected with contemporary EM systems, but 45 of these fields could be moved to dockside sampling and 70 could be collected with innovations in EM technology and changes in captain/crew practices.<sup>78</sup> Of the 31 data fields that were not likely to be feasible for EM to collect with innovations, all but 3 could be moved to dockside measurement.<sup>79</sup> As such, EM needs to be considered as a component of broader monitoring, control, surveillance, and scientific data collection systems.

## Barriers to EM Market Growth



Despite the benefits of EM, adoption of the technology has been slow. Almost twenty years after the start of the first pilot in the British Columbia crab fishery, there are only about 1 thousand vessels with EM installed, an average growth of just over fifty vessels a year. EM remains a regulatory-driven tool, and fisheries regulations change slowly. As one fishing industry representative said, “You need command and control mechanisms to get EM adopted. You cannot expect that this will happen voluntarily.”<sup>80</sup>

Processes for regulatory change are typically slow by design to ensure that new alternatives are carefully vetted and that there is ample space for different stakeholders to weigh in. The downside is that it can take a long time for change to unfold, and EM is often caught in these regulatory machinations. As a case in point, in the US, both the West Coast and New England groundfish fisheries have been running pilots and deliberating whether to adopt EM for years—the first pilots were launched in 2004 in New England and in 2007 for the West Coast groundfish.<sup>81</sup> These two fisheries are managed under the regional fishery management council system, which is a participatory and transparent governance process. In contrast, the Atlantic Highly Migratory Species (HMS) longline fishery was able to design, approve, and implement an EM program in tandem with an individual vessel quota (IVQ) program for bluefin tuna bycatch in a little over one year. This rapid adoption in the HMS fishery was facilitated by the fact that the fishery is managed under secretarial authority, which gives NMFS much greater authority for adopting and amending regulations than a typical fisheries management council process. As one fisheries regulator said, “it [getting EM adopted] is a people challenge, not a technical challenge.”<sup>82</sup> While there are important technical and design challenges to building an EM program, integrating key stakeholders into the design process and building buy-in may be an even more important determinant of success.

In order for EM to scale more quickly, several barriers and uncertainties—both perceived and real—need to be overcome. We present a simplified framework for discussing the barriers to EM adoption (Figure 5). This framework highlights four key barriers to the adoption of EM: cost, fishermen and seafood industry concerns, regulator concerns, and technological limitations. These barriers all contribute to slowing the regulatory process and limiting the uptake of EM systems. The following sections provide an overview of each barrier.

Figure 5. A simple framework of barriers to regulatory adoption of EM

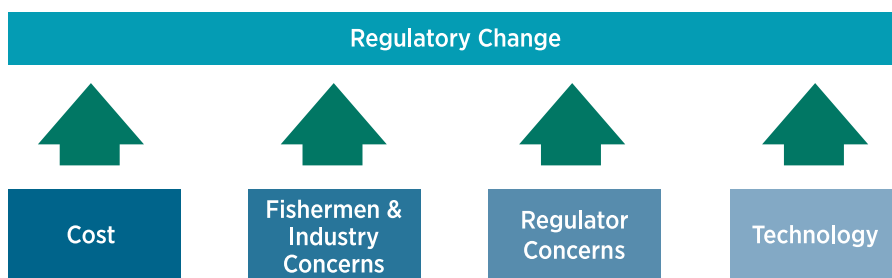

## 1) Cost

The most commonly voiced concern about EM is the cost, as both fishermen and fisheries managers are understandably reluctant to take on additional expenses. NOAA's webpage on EM says, "By far the most talked about challenges are the relative costs of various approaches and who pays for these new technologies."<sup>83</sup>

Unfortunately, what seems like a relatively straightforward question to answer—how much does an EM program cost—can be difficult to break down. Differences in the goals and designs of EM programs can have a huge influence on the overall cost of the program. Choices impacting cost include the number of cameras on each boat, the percentage of video that will be reviewed, the duration of video storage, the scale of implementation, the data that will be collected, and the compliance being verified (e.g., no discards versus complete enumeration). Likewise, characteristics of the fishery influence the cost of an EM program, including number of vessels, number of fishing days, geographic distribution of the fleet, and the type of gear. Studies also vary in their system boundaries and categorization of costs. For example, some choose to include the startup and ongoing costs for regulatory agencies, while others do not. Finally, cost data can be presented in different units—total cost, cost per vessel, cost per day, cost per fishing day, percent of net revenue—across different studies, which can make it difficult to quickly understand and compare how much EM programs cost for specific fisheries. That being said, in many cases EM is cheaper than human observers per unit of monitoring and this is at a relatively early stage in the development of EM technology. With continued advancements in hardware and automation of EM data analysis, the costs of EM systems will continue to decrease making them even more favorable compared to human observers. Although the return on investment of EM will vary, broadly speaking, the benefits of improved management enabled by EM will be far greater than the costs,<sup>84</sup> especially in fisheries with relatively high levels of fishing effort.

A challenge for EM systems is that some of the costs of other monitoring systems are already sunk, for example the design and start-up costs of a human observer program. This means that new sources of funding may be needed to get an EM program off the ground even if it is more cost-effective than existing approaches. Additionally, if EM systems are being considered in fisheries where there is little or no observer requirements then the costs of EM are largely additional and the relative efficiency of EM compared to human observers is less important. Instead, the costs of EM will be weighed against the benefits of improved monitoring.

Program design is the most important lever for controlling the costs of an EM program. While EM can collect a variety of information, program designers should carefully assess the cost-benefit of program objectives. Decisions about the goals of the program, what data are collected, and how it is stored can result in a huge spread in costs. Similarly, decisions about the percentage of video to review and how long raw video must be stored have major implications on the cost of the program.<sup>85</sup>

As an example, the regional observer program in the Western Pacific longline tuna fishery have at-sea observers collect more than one hundred data fields. EM could collect data for many of these fields but could prove quite costly or challenging for some (e.g., determining the sex of species, condition of discarded fish).<sup>86</sup> Program designers need to think carefully about the core objectives of their EM program and how it integrates with human observers and other monitoring tools (e.g., dockside monitoring, biological sampling, sea patrols) from a cost-benefit lens. Similarly, EM program design needs to consider the constraints of relevant institutions and capacities. As one EM expert said, customers need to think about the objectives before they think of the tools.

Technological advancements in hardware, video review, and data storage will be essential for ongoing cost reductions. In its current state, EM is a cost-effective tool for many fisheries and cheaper than human observers, but further cost reductions will be essential if the technology is going to achieve broad scale. AI advancements that have the potential to dramatically reduce video review time are a critical area of

development. Otherwise, the burden of finding enough video reviewers and the cost of analyzing and storing footage will stall the growth of EM.

Costs of EM can generally be broken down into three main categories: up-front fixed costs, annual costs, and indirect costs due to changes in fishery practices (Figure 6). Each of these categories is discussed below along with a discussion about how status quo monitoring systems have a huge influence on the perceptions of the cost of EM programs

Figure 6. Taxonomy of costs of an EM program

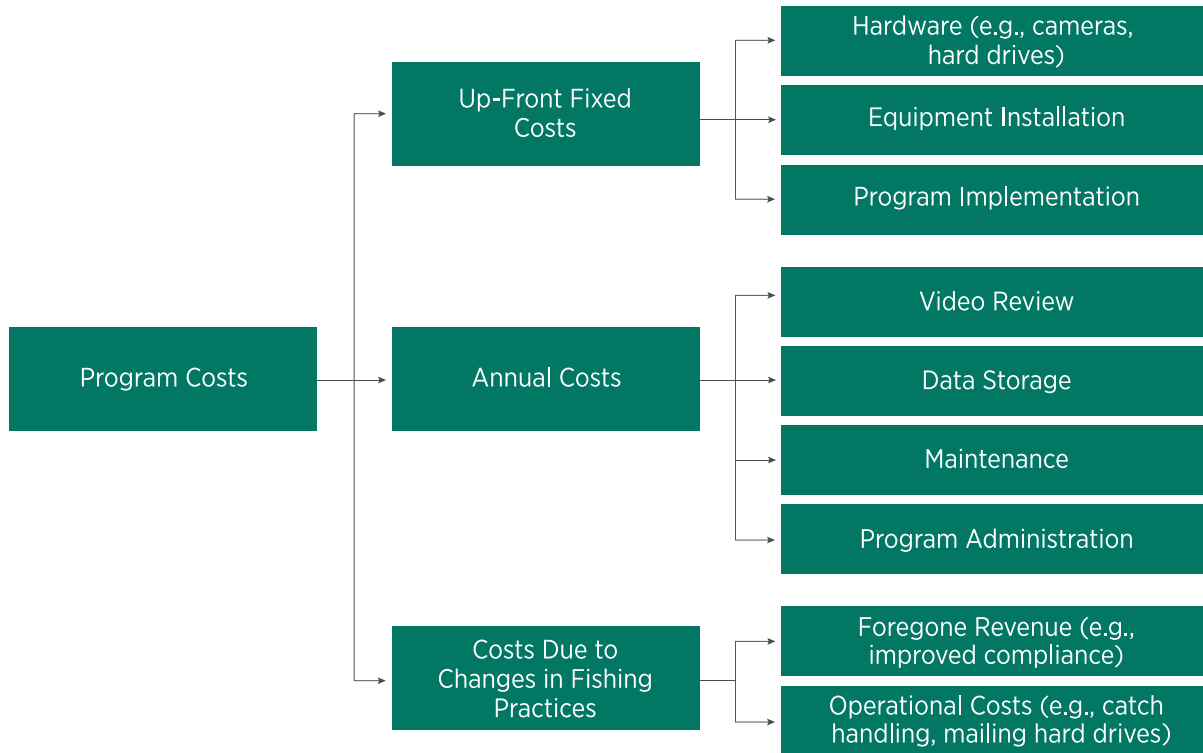

### Cost of EM Compared to Status Quo Monitoring Programs

Perceptions about the cost of an EM program are often driven by the current costs of monitoring in the fishery. If a fishery has a high level of at-sea monitoring with human observers, then EM can often deliver many of the same functions at a lower cost (Figure 7).<sup>87, 88, 89</sup>

Figure 7. Cost of monitoring with EM versus 100 percent at-sea observers

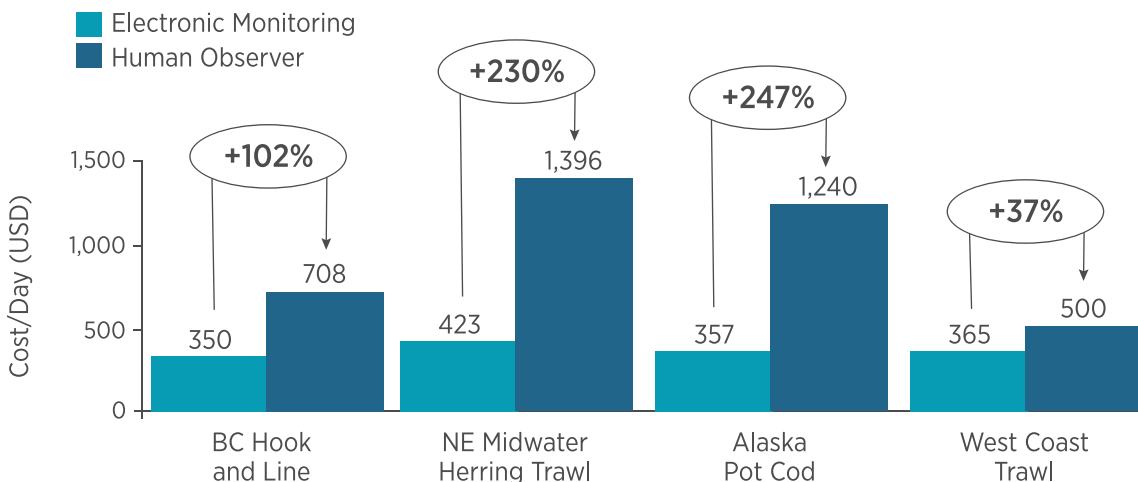



On the other hand, if a fishery has low levels of at-sea monitoring, the costs of EM are almost entirely incremental. In this case, the cost-benefit calculus is made against the uncertain benefits that 100 percent accountability will bring to the fishery as opposed to the relative cost of EM versus at-sea observers. In the US, the divergent trajectory of the West Coast groundfish and the New England groundfish fisheries illustrate how current monitoring requirements influence receptivity to EM.

**Figure 8. Cost of monitoring in the New England Groundfish fishery with at-sea observers and electronic monitoring.**

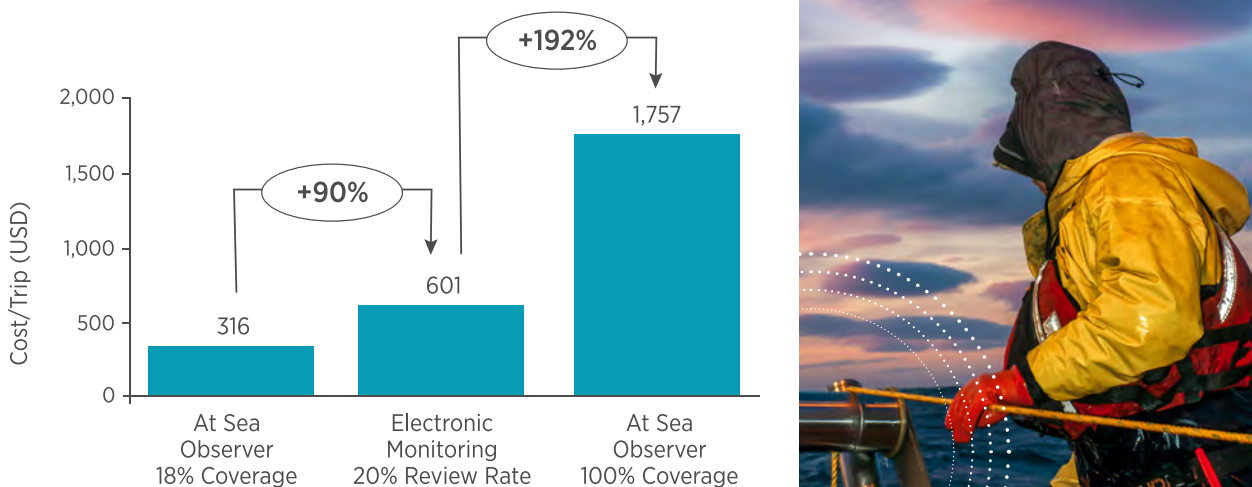

With the adoption of catch share management, the West Coast groundfish fishery simultaneously adopted a 100 percent observer requirement. With at-sea observer costs of approximately \$500 a day, there are strong incentives to move to EM, which has an estimated cost of \$365 per day for trawl vessels.<sup>90</sup> Not surprisingly, there has been a lot of receptivity and progress in moving EM to full implementation in West Coast groundfish fisheries.

On the East Coast, a different story has played out. Although the groundfish fishery moved to an output control management system in 2010, it did not simultaneously implement 100 percent at-sea monitoring. The fishery currently has just 15 percent at-sea observer coverage, the cost of which is heavily subsidized by government, and no dockside monitoring. The combination of low human observer coverage and government subsidies for the current observer program mean that implementing EM will be more expensive for fishermen than the current system (Figure 8).<sup>91</sup> This, paired with the uncertainty of what full accountability will mean for a fishery in which discarding is believed to be widespread, has resulted in vocal opposition to EM from parts of the fishing sector that are reluctant to bear the costs – often this is the portion of the fleet with the most compliance issues who stand to lose the most with full accountability.

As Dave Colpo of Pacific States Marine Fisheries Commission (PSMFC) said, “the biggest success factor [for EM] is 100 percent observer coverage, which brings industry to the discussion table in a way that does not occur in other regions.”<sup>92</sup> A challenge for EM, however, is that there are few fisheries like the West Coast groundfish fishery with comprehensive human observer coverage in place. Discussions about the cost of EM systems and compliance are typically divorced from the economic benefits of these systems, which are driven mostly by the improved fisheries management and health of target stocks that they enable. In these cases, costs become an easy scapegoat on which to base opposition to EM and full accountability. This challenge is not unique to EM. Almost every proposed regulatory change that has the potential to disrupt the economics of a fishery faces industry opposition.

In fisheries that have implemented EM, there is evidence of strong industry support, even in cases where they bear the cost of the program, indicating that they perceive significant value from the EM program. In British Columbia’s crab fishery, industry overwhelmingly voted to continue the EM program after three years of operation, including requirements for industry to pay for the capital costs and ongoing annual program expenses.<sup>93</sup> Similarly, the EM program in the British Columbia hook and line fishery has broad industry support in spite of costs that average 3.2 percent of ex vessel revenues and are as high as 20 percent of landed value for some vessels in the fleet.<sup>94</sup>

Although there has generally been strong support for EM programs that have been implemented, the cost still needs to come down. For some fisheries these cost reductions will tip the cost-benefit balance, while in others, where EM is already a cost-effective solution, it will weaken arguments against EM based on cost.

## Up-Front Fixed Costs

### Hardware

EM systems today typically consist of one to four cameras, gear sensors, a GPS unit, a hard drive, a monitor, a satellite modem, and a control center. In addition to these hardware costs, the systems require on-board installation by a trained technician. Equipment costs are usually in the range of a few thousand to fifteen thousand dollars or more, with the spread determined by the number of cameras and the complexity of installation (Table 1). Recently, some vendors have developed streamlined EM systems specifically designed for use in small-scale developing world fisheries with price points of about \$1,500 for a one-camera system.

While EM hardware costs can be substantial, they are generally spread over the lifetime of the equipment, which is typically more than five years. Although there are differences between fisheries, the up-front hardware and installation costs are often less significant than ongoing costs of review, data management, and program administration.<sup>95</sup>

Table 1. EM hardware and installation costs from selected studies

Fishery	Per Vessel Equipment Cost	Per Vessel Installation	Notes	Reference
New England Groundfish	\$8,900	\$2,400	Scoping study, not based on actual implementation	NOAA, 2015. <sup>96</sup>
New Zealand	\$7,000 - \$12,000	\$1,200 - \$2,400	Based on vendor quotes for regulatory impact study	Ministry of Primary Industry, New Zealand, 2017. <sup>97</sup>
Marshall Islands Tuna Longline	\$14,000	\$4,200	Small pilot of six vessels; remote location and low volume impact installation costs	The Nature Conservancy, 2018. <sup>98</sup>
US West Coast Groundfish	———— \$10,000 ————	————	Based on vessels fishing under the exempted fishing permit	NMFS, 2016. <sup>99</sup>

Hardware performance continues to improve with technological advancements of the key components (e.g., cameras), and some price improvement is likely in the near-term. But, given the relative maturity of many of the components used in EM systems, hardware price declines aren’t likely to drop precipitously in the coming years.

## Program Development

Setting up an EM program also requires significant investment on the part of the regulatory agency. This can include staff time or consulting support around program design, training staff, legal review, auditing of EM vendors, integrating EM to the overall monitoring program, and the purchasing of equipment. These costs are not trivial. NOAA estimated that implementation costs for an EM program in the New England groundfish fishery would be \$558 thousand for 20 vessels and \$1.4-\$1.7 million for a 400-vessel program.<sup>100</sup> As this example illustrates, there are some economies of scale with program development costs. These costs are also likely to come down as experience with program development grows.

## Annual Costs

While the up-front costs of EM systems can garner a lot of attention, in general the ongoing costs of EM programs comprise a larger share of total costs (Figure 9).<sup>101, 102, 103, 104</sup> These costs include video review, data storage, operations and maintenance, and program administration expenses. These expenses, especially video review and data storage, are strongly influenced by program design decisions such as the data fields that EM will actually collect, the percentage of footage that will be reviewed, who will review the video, and how long it will be stored. Dave Colpo of PSMFC emphasized the importance of program design saying, “These [data storage] costs could end EM programs; information needs must be balanced with costs.”<sup>105</sup>

Figure 9. Breakdown of costs in various EM programs

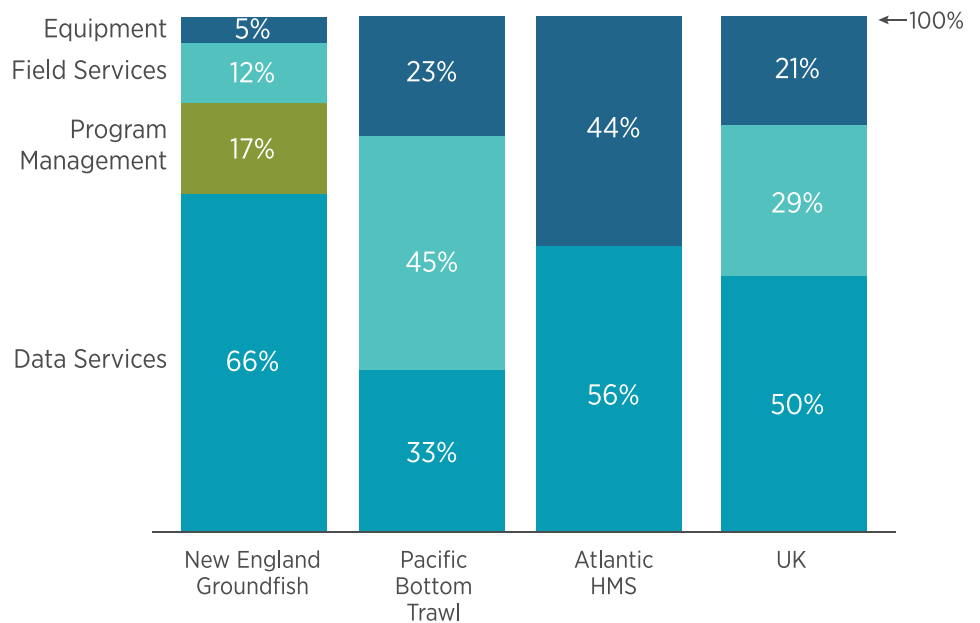

Hook counts in EM trials in the Pacific longline fishery are an example of how decisions about what data to collect and how it will be collected can have a huge influence on ongoing costs. In this fishery, observer forms require enumeration of hooks in between floats to provide data on the depth of individual caught organisms. This is useful information for fisheries science, but hook enumeration consumed roughly 40-50 percent of video reviewer time in EM trials, which raises the question about the value of collecting this information at all relative to its costs of acquisition or at least how to make this process more efficient, especially since on-board observers often make rough estimates of which hook between floats an organism was captured on.<sup>106</sup>

Decisions about what proportion of video needs to be reviewed and how long data will be stored are also paramount to keeping costs down. While the percentage of footage that should be reviewed will be influenced by the objectives and data needs, programs have been successfully implemented with 10 percent auditing rates essentially slashing video review costs by 90 percent. The choice of how long to store data is also multi-faceted, but the ability to purge raw video footage in a relatively short amount of time can significantly reduce costs.<sup>107</sup> Australia’s fisheries management authority, for example, received an exemption from the government’s standard seven-year storage requirement for EM video, to allow purging after six months.

Experience suggests that fishers also play an important role in reducing video review costs. This can happen in a couple of different ways. First, through feedback between video reviewers and captains and crew onboard catch handling processes can be refined to allow for more rapid review of fishing events. Second, in some programs fishers can become more efficient at avoiding fish that require on-board catch handling or presentation to the camera, thus reducing the amount of video that needs to be reviewed.

Software advances for video processing and analysis have great potential to cut data service costs. The holy grail is image recognition that can reliably identify species, weights, and lengths of fish in highly variable fishing environments, but in the nearer term continued advancements in automatically flagging key events, reducing file size or image rates based on activity, truncating video footage for review, and tools to improve the efficiency of EM analysts can put downward pressure on review costs. According to one EM provider, this progression is well underway. “In the last year and a half, there has been the introduction of new camera technology and AI embedded into different stages of EM that have allowed for truncated video selection and faster review.”<sup>108</sup> These advancements will also facilitate the evolution of video transmission from physical mailing of hard drives, which happens in many programs today, to transmission via in-port Wi-Fi, cellular, or satellite networks. Continuing to push these technological advances could further open the available EM market and receptivity to the tool (see technology section below).

### **Maintenance**

The operating environment for EM systems is especially challenging. Exposure to the weather, spray, and sometimes low-quality power supplies make continuing maintenance, to a certain degree, inevitable. Estimates for annual maintenance costs vary but are on the order of \$1 thousand to \$2 thousand per vessel.<sup>109, 110</sup> The robustness of systems is improving, and generally improves within a specific fishery after some initial teething pains. Each service call, however, can be quite costly. Most vendors will deploy their own technician to the field for service calls, which can be especially costly in remote locations (e.g., the Pacific Islands, Australia, parts of the US) where there are not enough systems in place to warrant a field technician. It also can result in significant delays before the system is operational again. Improving the serviceability and modularity of EM systems may be a ripe opportunity to bring down the ongoing costs of maintenance for EM systems moving forward.

Some have argued that these field service calls are a critical face for the EM program and facilitate a dialogue with captains and crew about their responsibilities and feedback for program designers. This additional function of field service technicians should be considered as service efficiencies are realized to make sure that there are other effective points of interaction with industry about EM programs and vessel monitoring plans.

### **Technology**

Advances in processing power, chip design, and the availability of huge data sets have brought AI from a promising concept to something that is regularly touching people’s everyday lives. From Siri to facial recognition on Facebook, and from real-time mapping services to detecting fraudulent banking transactions, AI supports many mainstream products and business services. Almost every sector is excited about how these tools can revolutionize their field, including fisheries. As one fisheries regulator said, “The whole operating model for how you use the data is more challenging than we thought. In the longer term, we are desperate for AI technology in this space.”<sup>111</sup>



The obvious application of AI in EM is using software to automatically filter huge volumes of video to key events, and ultimately enable the automatic conversion of raw video into processed data. In the near term, having software reliably identify events, such as the presence of a fish on deck, could allow for much better pre-processing of the video data and significantly reduce review times and storage costs. For example, a project in the US Atlantic HMS fishery was able to correctly flag fishing events 99.2 percent of the time, which could reduce video monitoring time by 40 percent, although it was not clear what the benchmark was in this study to estimate reductions in video review time.<sup>112</sup> Some vendors say they offer AI that is already capable of delivering significant reductions in video review, although this has not been proved at a commercial scale.



Automatic species, length, and weight classification is the ultimate goal and research, and development efforts have already demonstrated this capability, including:

- A University of Washington and NOAA collaboration has achieved greater than 95 percent species identification accuracy and length estimates with 2-3 percent margin of error for a Pacific multispecies fishery using a prototype chute-based system. This same team is also developing software to identify species as they come aboard during rail fishing operations and software that can flag behavior anomalies (e.g., if a fish comes on board and is not taken directly to the fish chute for species identification and length measurement).<sup>113, 114, 115</sup>
- The Nature Conservancy organized a Kaggle Competition to solicit algorithms that could automatically detect and classify species caught in tuna longline fisheries. The winning submission was close to 100 percent accurate in fish count and 75 percent accurate in species identification.<sup>116</sup>
- In Europe, the University of East Anglia and Marine Scotland are partnering to develop automated image analysis from EM systems on Scottish vessels. The research has been able to achieve accurate counts of fish,<sup>117</sup> but requires further refinement of species identification.<sup>118</sup>

Successful development and application of AI and image recognition has the promise of reducing the cost of video review and storage and allowing for onboard video processing. The latter is a crucial step for real-time transfer of fishing data, which is currently constrained by the cost of transmitting huge volumes of video from vessels at sea—video footage now is transferred by physically mailing or collecting hard drives. Some researchers are looking even beyond these initial applications, such as using underwater cameras in nets and using software to detect the presence of protected species to trigger the opening of escape hatches. This is encouraging, but there are still some ways to go and large hurdles between the current state and the seamless AI-enabled future that is envisioned.

In addition to these software advances, other technological developments may enable EM programs to collect an even wider array of data. For example, DNA scanners may be able to assess the sex of fish species and thermal cameras may help categorize the condition of discarded fish (e.g., alive, degree of injury, dead).<sup>119</sup>

These technological advances need to be supported, but the barriers to rapid development and adoption of these technologies should also be recognized, including:

- Development cost versus limited market size
- The significant gap between a research and development prototype and a robust product
- Challenging environments for image recognition (e.g., moving fish, water and salt on lenses, variable backgrounds (e.g., waves, sun, clouds), and variation in fishing vessels)
- Variation in fisheries and monitoring needs (i.e., requiring somewhat custom solutions for each fishery and within fisheries)
- Limited availability of adequately labeled training data
- Little coordination between research efforts and EM vendors
- AI may compete with video review profit centers of some EM vendors

In addition to these barriers, some EM experts are skeptical of the near-term impact of AI believing that it will not be able to meet the variety of monitoring needs in fisheries and would eliminate human touch points that are critical to building shared trust in EM data and program success. For these stakeholders, the potential of AI is being overstated and investment may yield more returns in some of the more mundane parts of program design, such as designing efficient video audits.

In spite of the challenges and competing viewpoints on the likely impact of technological change, some investment seems prudent to further technological advances that could improve the cost-effectiveness and capabilities of EM. Ultimately these advancements are essential for EM to achieve broad scale. Perhaps the adage of Silicon Valley pioneer Roy Amara is an appropriate lens to think about this development: “We tend to overestimate the effect of a technology in the short run and underestimate the effect in the long run.” In the meantime, stakeholders should recognize that EM can cost-effectively deliver critical improvements to monitoring systems today for many fisheries, and that program design decisions (e.g., program goals, video review rate) have an enormous impact on the cost and value of an EM program.

## Costs from Changes in Fishery Practices

Although often not explicit in discussions about the cost of EM, the costs due to changes in fishery practices can be an important, if not the biggest, reason for resistance. The full accountability that EM programs bring can trigger major shifts in the way that industry operates. This is the flip side of the compliance benefits of EM. Fisheries where widespread discarding, high-grading, or illegal transshipments take place face huge uncertainty about the viability of their business when EM brings fuller compliance to the fishery. Even if fishermen believe that EM will level the playing field, they can still have doubts about how quickly it will lead to tangible economic benefits for the fishery and how their competitive position may change under the new paradigm. For many, the certainty of the status quo—no matter the flaws—is more attractive than the uncertainty of change.

This is playing out right now in the New England Groundfish fishery, New Zealand, and the implementation of the discard ban in the EU. In these examples, discarding of choke species is believed to be widespread and vessel operations and economics have become dependent on this reality. In these contexts, full accountability can seem like an existential threat to the viability of industry. Not surprisingly, the rollout of improved accountability and EM has faced significant opposition from parts of the fishing industry in these regions.

EM can also bring additional labor to at-sea operations. For example, depending on the goals of the program, it may require fishermen to sort and measure fish in front of a camera. This additional labor can slow down catch-handling procedures and can be especially challenging in higher-volume fisheries. Installation and maintenance can also leave vessels stuck in port.

## Recommendations to Support EM Cost Reductions and Technological Advancements

- **Support technological advancement** – Looking ahead, software developments have the potential to dramatically reduce the cost of video review and storage through better pre-processing and tagging of videos, more efficient review software, and ultimately by using image recognition to automatically convert video to usable data (e.g., catch estimation, length, species identification, flagging of human behavior anomalies). Similarly, technological developments can unlock new cost-effective applications of EM. The community should pursue strategic investments to support this technological development, such as:
  - Create a secure, open-source collection of labeled and anonymized EM video that can be accessed to develop AI and image recognition software.
  - Foster better communication between current research and development efforts (e.g., National Oceanic and Atmospheric Administration and University of Washington) and EM vendors to catalyze adoption of new tools by EM vendors.
  - Catalyze R&D and trials of new technologies that could be integrated into EM systems (e.g., weight sensors on winch used to brail the catch by purse seine vessels and on cranes used to transship catch between vessels at sea)
- **Improve the efficiency of the EM vendor market** – The EM market is small and relatively low margin, and it has historically been slow growing. Faced with these factors, many service providers are risk averse and dependent on long-term, exclusive, service-oriented contracts. Ultimately, bringing the cost of EM down and scaling demand will bring about a more robust EM market, and the following interventions may help speed up this natural evolution of the industry.
  - Explore the development of an industry association that can pursue activities that lift the entire EM market, including:
    - Advocating for policy that supports EM
    - Conducting market development activities
    - Developing interoperability standards (e.g., standards that enable video coming off of any EM hardware system to be used by any EM review software, standards that enable easier integration with other data streams)
  - Convene buyer consortiums to make procurement requests for quotation (RFQs) more consistent and help to drive forward shared interests (e.g., interoperability). As the market matures in the future, as part of those procurement standards, look to disaggregate services (e.g., hardware, software, video review) to increase competition over time.
  - Pursue the use of program-related investments (PRIs) to the EM vendor community, and competitions and prizes to ensure that vendors remain growth-oriented and open to potential risks (e.g., software evolution).
- **Explore cost sharing opportunities, incentives, and business models to mitigate or amortize program costs** – As in almost all regulatory debates, the cost of EM and who will pay for it is typically the most-talked-about concern. While EM is often less expensive than comparable levels of human observers, few fisheries have high levels of at-sea observers in place. In these cases, mitigating program costs can increase buy-in and support. Hardware and other up-front costs are steadily declining, but the industry is still in its initial stages in which systems are cost on the order of \$10 thousand a vessel. To help overcome cost barriers, especially up-front costs, stakeholders should explore opportunities such as cost sharing with the government, philanthropic support, financing, PRIs, new business models (e.g., EM as a service, secondary uses of EM data), and incentives for EM adopters (e.g., additional fishing quota).

## 2) Regulator Concerns

In addition to concerns about the costs, regulators face many operational and design challenges to build a successful program. The following sections provide an overview of some of the practical challenges that regulators face in developing an EM program as well as a specific discussion of the difficulties of handling and integrating new EM data streams into fisheries management. An overview of some of the key EM data and system design considerations can also be found in Appendix D.

### Complexity of Transitioning to EM

Incorporating EM into a monitoring, control, and surveillance program requires a significant investment of time, energy, and resources by fishery regulators. Describing the process of rolling out EM, one regulator said, “It doesn’t sound like it should be, but it is quite a complicated program when you overlay political uncertainty, stakeholders jockeying for position, plus the ramifications if we roll out the first tranche and have done something wrong.”<sup>120</sup>

EM program development requires identifying and agreeing on key objectives, getting the right legislative and regulatory drivers, agreeing on data standards, and having the right consultation process with industry. As one regulator summarized, “It sounds really simple, but we had no idea as an agency what we were doing.”<sup>121</sup> Even writing an effective RFQ can be challenging for an agency that has limited experience with EM. Human resources on staff may not be well suited to the needs of an EM program either, which may demand more information technology (IT) staff or “dry” observers.

On top of these technical challenges, finding the funds and human resources needed can be daunting. Ideally, an EM program can reduce the resource requirements of other parts of an agency’s overall monitoring program (e.g., aerial patrols, inspections), but it is difficult to take this type of systems-level approach. Budgets are often siloed and it can be easier to maintain current funding allocations than to access funding for new initiatives.

Fortunately, there is a growing body of knowledge about how to implement EM programs and evidence that they are effective. While regulators in each new geography still face a challenging learning curve, there is a great opportunity to share lessons learned from regions that are further along the experience curve. The complexity of designing and implementing an EM program are manageable, and guidance from those who have navigated the process before can help in smoothing the process, avoiding common pitfalls, and ensuring successful programs with widespread support.

Likewise, there is also an opportunity to move regulators out of many functions and outsource EM program management to 3rd party vendors. In this case, the regulator’s role becomes focused on developing performance standards, certifying vendors, and ensuring that EM vendors continue to meet those standards. Even the US, which has in-housed many of the components of their EM programs to-date, is exploring outsourcing more to 3rd party vendors. Other regions exploring EM may jump directly to this 3rd party approach which can mitigate many regulator concerns about how to design and implement an EM program.

### Managing Data and Privacy Issues

One of the more challenging issues for regulators has been how best to manage data ownership and privacy concerns associated with that data.

Recording video from hundreds of vessels fishing every day results in a flood of unprocessed video and data streams for agencies to manage. For just twenty vessels in the New England groundfish fishery, it is estimated that EM would generate 168 terabytes of data every year (a typical laptop has about half a terabyte of storage). Similarly, the Atlantic HMS fishery generates about 200 gigabytes of data per trip and had data storage costs of \$194 thousand in 2016.<sup>122</sup>



Managing this volume of data requires thoughtful decisions about how to store it (e.g., in-house, in the cloud, with a third-party vendor), how long it should be stored, how often it will be accessed, and who will be able to access the video. There are arguments for longer-duration storage, such as the ability to look retrospectively at fishing video in light of new evidence of serious violations, and that there is potential value in the video and data that could be realized in the future. The longer the storage time, however, the greater the cost. Similarly, there are arguments for different models of access to and ownership of EM data, with some balance between government, industry, and 3rd party vendors. Clarifying who owns, has access to, and the security of video and extracted data is a complex question. Programs must effectively balance privacy concerns of crew, captains, and vessel owners with the data needs of fisheries managers and other stakeholders, and this balance point could vary widely by region or fishery.

Regulators must also integrate the new data streams from EM into their operations. For example, how will EM data be shared across different management functions (e.g., enforcement, science), how can new EM data on catches be integrated into time series data for stock assessments, and how does EM dovetail with electronic reporting?

As noted by one of the newer EM technology providers, “Many potential government agency customers have never had to deal with the level of data that EM systems can generate. We need to provide consulting support to government agencies to help them build the needed capacity to utilize the tools and the data. Otherwise any ambitious program will implode under the weight of data and systems.”<sup>123</sup> These are all basic design and operational questions, but ones that need to be carefully thought through during EM program development.

In the absence of clear answers to these questions, individual fishery managers or regulators can be reluctant to implement new systems at scale.

## Employment Concerns

In some cases, EM programs raise concerns about employment impacts, especially when there is an at-sea observer program that will likely be scaled back with EM. These concerns are most acute in regions where economic development and job creation is one of, if not the primary concern of regulators, for example the Pacific Islands. The ultimate impact on jobs will depend on a variety of factors, such as the coverage of observers before EM, the number of observed trips displaced, and the required labor for new EM functions. In cases where EM is scaling up the monitoring coverage levels of a fishery, it has the potential to increase jobs. In the cases where at-sea observers are significantly scaled back, some jobs can be shifted to high value functions in safer working environments, such as biological sampling at dockside, video review, and EM installation and repair, but there may be job reductions. In the long-run, automated video review may impact employment in EM programs, but when this will happen at meaningful scale is still highly uncertain.



## Recommendations to Build Regulator Support for EM

### Build broad demand for EM through subnational, national, and regional commitments

- **Make EM a national/regional priority** – EM has the potential to increase transparency and confidence in what is happening on the water, which can dramatically improve fisheries management and compliance in fisheries with science and data gaps. Despite the promise of the tool, the market for EM remains small, fragmented, and low-margin. In this context, vendors are reluctant to make investments to improve performance, but regulators are reluctant to commit to EM until performance improves. To help break out of this paradigm, prioritization of EM can drive rapid uptake of programs. Policy mandates can be an effective approach if there is buy-in across stakeholders, but even increased support for and prioritization of the tool, like in the US, can drive uptake. This should include explicit budget allocations for EM development and implementation. In some contexts, subnational bodies may be an equally important champion for EM, for example the regional fishery management councils in the US. Immediate priorities include accelerating EM adoption in countries currently moving forward with EM (e.g., the US, Australia), overcoming opposition to the policy mandate in New Zealand and pushing through to implementation, and promoting regulatory support of EM in regions actively considering the tool (e.g., actively supporting implementation of the proposed EU fisheries control regulation in member countries and building off Parties to the Nauru Agreement (PNA) leadership to make EM mandatory for tuna licensing in Pacific Islands Forum Fisheries Agency (FFA) countries). Looking ahead, additional opportunities include expansion of Pacific Island nation commitments to WCPFC mandates for EM, expansion to additional RFMOs, broad-based EM requirements in Northern EU member states, introducing EM to North Asia (e.g., China, Japan, Korea), building EM commitments in middle-income countries with important industrial fisheries (e.g., Peru, Chile), and further trialing low-cost small-scale fishery EM options in other critical fishing nations (e.g., Indonesia, Thailand).

### Assist regulators with EM program design and implementation

- **Provide program design assistance** – To support more effective program design (e.g., defining objectives, data storage standards, review/audit design) the community should:
  - **Develop best-practice toolkits** for EM design or design manuals. These toolkits should provide guidance and best practices for determining program priorities, goals, and objectives; program management and enforcement; technology and system architecture; data collection and management structures; cost management and sharing approaches; managing data confidentiality and privacy issues; addressing legal issues; designing effective stakeholder outreach processes; and writing effective RFQs. A well-designed toolkit, especially when paired with other outreach approaches, can help fisheries managers quickly get up to speed, understand the full suite of issues that need to be addressed while developing an EM program, and avoid previous mistakes and common pitfalls. The Nature Conservancy recently developed an electronic monitoring program toolkit, which is an effort to fulfill this need.<sup>124</sup>
  - **Build a global expert working group** to provide technical assistance to fisheries designing new EM programs. The Regulatory Assistance Project (RAP) is a useful analog from the power sector that could serve as a model. Currently, it is challenging for fisheries regulators to identify neutral parties to provide guidance on EM program design and information. EM vendors have contributed much useful information, but there are potential conflicts of interest with them providing up-front technical assistance on system design when they may also ultimately bid on an EM project. NGOs

have sought to fill that void and will continue to have a key role as experts who have experience with EM across a variety of geographies and fisheries. Creating a neutral multi-stakeholder expert working group capable of delivering on-demand guidance to governments around the world is essential. It should include former regulators, fishermen, NGOs, and EM vendors capable of providing detailed technical recommendations. Ideally, this type of expertise would be provided as a free service to governments that are considering a transition to EM. Currently, there is no coordinated outreach to introduce or promote the potential of EM systems to regulators outside of the main implementing countries or in international fora.

- **Facilitate regulator convenings** and information sessions to allow for transfer of best practices. There should be a more concerted, proactive effort to share information on the current state and promise of EM with regulators. That includes focusing on parts of the world (e.g., Japan, Korea, China, Chile, Peru, Mexico, Indonesia, the Indian Ocean) where there has not yet been a major focus on independent monitoring or camera systems. Convenings should also be facilitated between regions where EM development is already underway, for example an EU and US collaboration or an Australia and New Zealand relationship or developing a working group within the International Council for the Exploration of the Sea (ICES) to build momentum and interest in EM for EU fisheries. In these conversations, convening regulators from other jurisdictions to share lessons and compare notes on challenges would be a useful tool. A key outcome of this work would be the harmonization of EM technical and performance standards across the globe. Ultimately, we envision an annual or biennial regulator conference to share information and best practices across disparate geographies. This effort could also be synchronized and integrated with the work of a global expert working group as described in the previous recommendation.
- **Design pilots to lead to widespread implementation** – Numerous EM trials have failed to extend to broad program implementation. There are many reasons for this, but a common refrain is that most pilots are not specifically designed as a clear stepping stone to broad implementation (i.e., they may be in a niche part of a fishery, only explore general capabilities of EM, fail to test the design elements of a program at scale, or do not allow for rapid testing and iteration). Political commitment to define the criteria for a successful trial and what success will trigger is often lacking. Recognizing that sometimes you have to be opportunistic and work with the amenable parts of the fleet, the community should strive to ensure that new EM pilots are designed and structured to test a program design intended for broad-scale implementation, rather than the technical feasibility of EM operation on a given vessel. For example, pilots should include a meaningful number of boats that are representative of the fleet, ensure coordination of individual pilots within a fishery or management region, include key stakeholders that will be required for broad implementation from the beginning, and test key system design elements (e.g., auditing rates, cost at scale, integration with other monitoring mechanisms). For example, The Nature Conservancy’s project in the Western Pacific tuna longline fleet is bringing together countries, industry, and regional institutions and is explicitly designed to test and build the foundation and processes for a regional program and scale. Selecting the right vehicle for testing is also important. For example, the exempted fishing permit structure in the US can provide a lot more flexibility than pilot programs.
- **Promote and facilitate multi-stakeholder groups to inform program design in major growth regions** – EM programs have many different stakeholders—fishermen, regulators, scientists, NGOs, EM providers, IT staff—each with varying perspectives, objectives, and concerns. This means, according to one regulator, that “it [EM] is a people challenge, not a technical challenge.” Regionally targeted, multi-stakeholder groups can help incorporate viewpoints from various stakeholders and facilitate dialogue about design decisions and tradeoffs. This can ultimately improve program design and build

critical buy-in for the program. These working groups ideally include a cross-section of stakeholders and should be tasked with answering specific questions with clear deadlines to inform EM program development. Ideally, these will be formed with government support and leadership so that their work will have a clear mandate and will flow directly into the regulatory process. The Alaska EM Working Group is an example of a productive multi-stakeholder working group that has helped to advance EM in the region and to build relatively broad-based support for the technology. In addition to other regional EM working groups in the US, immediate opportunities include supporting Pacific Island working groups to advance EM in the WCPFC, and perhaps increasing support for the Integrated Electronic Monitoring and Reporting System (IEMRS) Technical Working Group in New Zealand, where rollout of EM has slowed in the face of stakeholder opposition and with a change in government.

- **Continue to document and communicate the current state of EM and chart a pathway forward** – Although there is a growing body of literature on EM pilots and programs, stakeholders considering EM can still be uncertain about whether it is the right tool for their specific fishery. Continuing to document and share outcomes from EM trials and programs will build a stronger body of evidence in support of the application of the tool in a variety of contexts. There are a variety of platforms already in place for disseminating the latest knowledge: 1) ‘EMinformation.com’ is a helpful online repository for reports and progress on EM around the globe; 2) there have been two NOAA-organized biannual EM workshops in the US, with a third slated for 2019; and 3) EM is taking an ever-more pronounced role at the International Fisheries Observer and Monitoring Conference. With the EM market slated for significant growth, the time is right for a global EM-specific workshop to gather a broad field of regulators, funders, EM providers, fishing industry representatives, and NGOs to build a shared understanding of the state of EM and inform a collective roadmap of action to accelerate uptake of the tool globally.
- **Support agency data modernization efforts that will allow for the efficient and seamless integration of EM data with other systems (e.g., electronic reporting) and agency functions** – EM is one component of growing monitoring data streams for agencies. Without modern and efficient data systems, agencies will not be able to capitalize on the benefits that EM data can yield. Similarly, there are parallel conversations about how best to use remote sensing data, vessel tracking data (e.g., VMS, Automatic Identification System (AIS)), and how to track fisheries data transparently through supply chains. These threads need to be woven together. The Fishing Data Innovation Taskforce in the US recently generated a set of recommendations for transforming fisheries management data systems to meet this new reality. Birddogging and promoting the recommendations of the task force will be important supporting work to advance EM. This taskforce should serve as a model for other regions that need to bring their data systems into the 21st century. A laudable vision is for fishermen to be able to securely and seamlessly submit their trip reports with the push of the button with all the required information auto-populated from EM systems, electronic logbooks, and other digital systems. Data would then be immediately integrated into management systems (e.g., catch accounting systems, bycatch maps) to improve the efficiency of fishermen and fishery managers alike.



### 3) Fishermen and Seafood Industry Concerns

In many countries, co-management and multi-stakeholder governance processes mean that fishermen have a critical voice in determining whether or not EM programs will be piloted or implemented. In the US, for example, fisheries management measures are recommended through Regional Fishery Management Councils. These councils have representation from a diversity of stakeholders, including harvesters and other seafood industry representatives. Therefore, demonstrating the value of EM and addressing industry concerns about EM programs is essential for scaling the tool. Moreover, where those systems are implemented, their success ultimately requires buy-in from the fishing industry. As one expert said, “We’ve learned that EM programs are difficult to implement where user acceptance is low – if appropriately motivated, industry has no end of energy to show you why the technology will not work on their boat. In contrast, when they support it they come up with lots of ways to make it work more reliably and in better ways.”<sup>125</sup> Industry has played a critical leadership role in developing many of the EM programs that are in place (e.g., BC crab).

Integrating the seafood industry into EM development processes is essential to support growth of the tool, ensure the program design reflects the realities of on-the-water operations, and cultivate the buy-in that is essential for EM programs to be successful.

But, there is a paradox in trying to build support for EM among fishermen. Those who have good practices on the water do not necessarily see any need for EM, while those who are not following the rules have reason to worry about additional monitoring. Overcoming that opposition has typically required the existence of a strong compliance or management issue that needs to be solved (e.g., gear theft, rampant discards), integration of harvesters and other seafood industry representatives into the design process, and exposure or experience with EM technology. Once fishermen have actual exposure to EM, they generally have a more positive perception of the tool and it is easier to have an informed dialogue about the applications (Figure 10).<sup>126</sup> As discussed in the benefits section of this paper, identifying and demonstrating ways that EM can provide value to industry (e.g., traceability, business analytics, meeting retailer demands, building shared trust in data) is another essential lever for building industry support that will be essential for EM to scale.

Broadly speaking, fisher opposition can typically be classified into cost-benefit concerns and privacy issues.

#### Costs with Uncertain Benefits

The costs of comprehensive EM can be a substantial share of overall revenues in some fisheries. The cost of the EM program in the British Columbia hook and line fishery averages 3.2 percent of landed value for the fleet and is as high as 20 percent for some vessels.<sup>127</sup> Similarly, an ex-ante study of adopting EM for the New England groundfish fishery estimated EM costs at roughly 7 percent of landed value for fixed gear vessels.<sup>128</sup> In these cases, the cost of EM is much less than human observers, but in many cases, EM is being considered in places with little or no human observer coverage in place. The prospect of covering all or part these costs

Figure 10. Are you generally for or against the use of EM with cameras? Survey responses of EU fishermen with and without experience with EM.

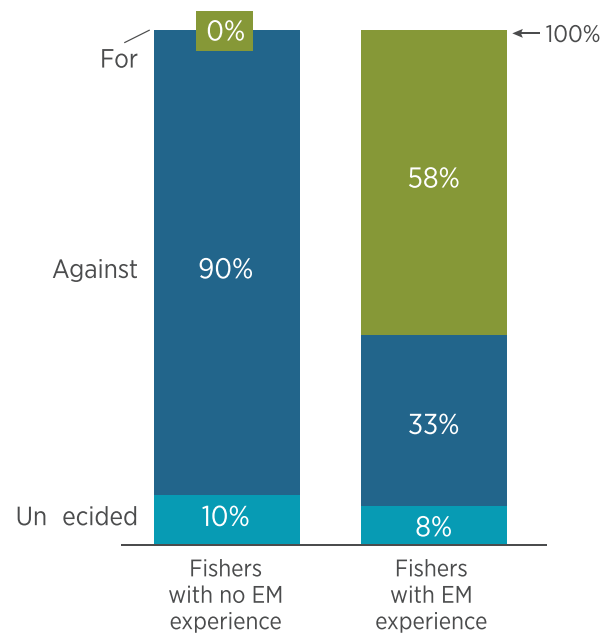

can be daunting. Many fisheries are low-margin businesses to begin with and see little capacity to add additional cost to their operations. Even where agencies have agreed to cover the hardware and program costs, fishermen can be concerned about the changes in fishing practices that EM may necessitate. As previously discussed, EM has been used in some fisheries where at-sea compliance issues around discarding and high-grading are problematic. In those fisheries, ending these practices can negatively impact the economic viability of some fishermen (at least in the short term). While stamping out compliance issues and leveling the playing field in fisheries is in the public interest and the long-term interest of the fishery, it will have real economic impacts to industry that need to be considered.

The costs of EM adoption are clear for fishermen, but the benefits are much more uncertain. The most important benefits are ensuring compliance across all actors in the fishery and improving fisheries management. It is rarely clear in advance how much benefit fishermen will realize from these changes. Similarly, other potential benefits from EM, such as market access, sustainability claims, traceability, data licensing, and improved business analytics, have not been well documented. Without further development of these potential benefits, most fishermen will continue to view EM primarily as a compliance tool.

## Privacy Concerns



Nobody likes to be surveilled at work, and fishermen are no different. One regulator emphasized this sentiment saying, “I have read submissions from individual fishermen about EM and they feel it really deeply . . . they see it as an invasion of their very being. You have to read what they write to understand how deeply they feel this.”<sup>129</sup> There are a host of concerns about having their operations recorded including divulging of “trade secrets,” manipulation of video or sensational use of footage (e.g., dolphin bycatch), liability, and basic opposition to being recorded on principle. Fishermen may also be concerned that video will dramatically increase the likelihood of being sanctioned for minor violations, although in reality, managers and video reviewers are not interested in minor issues.<sup>130</sup>

These are solvable challenges but require careful deliberations that balance the desire for privacy with the potential benefits of what access to video and data could provide. At a minimum, this balance should ensure confidence in the data that is being collected and used to inform fisheries management decisions and to support sustainability claims in the market.

## Recommendations to Build Fishermen and Seafood Industry Support for EM and Cultivate Private-Sector Leadership

- **Support industry leadership in EM program design** – Support seafood industry participation in EM working groups to ensure that key concerns (e.g., cost, privacy, enforcement) and the operations of the fishery are incorporated into program design decisions. Several experts believe that EM providers have had a narrow focus on regulatory agencies as the customer, and that the field should pivot to become more industry-facing. Working groups can bring together EM providers, regulators, and fishermen to collaboratively design, test, and implement programs that balance the sometimes-competing desires of the different stakeholders and actively bring fisher perspectives into the discussion. The establishment of an EM working group in the Alaska was one of the region’s biggest success factors and established an inclusive process that has thoroughly taken fishermen’s concerns into account and was critical for designing programs that were actually feasible to implement on the water.
- **Increase business incentives for EM adoption** – EM is often seen primarily as a compliance tool. Either fishermen are already following the rules, in which case cameras can feel like an imposition, or they are not, in which case cameras can present a liability. To build support from the industry, the field needs to demonstrate the benefits of improved fisheries management that result from EM and cultivate greater market benefits for fisheries with EM, including:
  - **Demonstrate the benefits to industry from improved management enabled by EM.** The primary benefit that EM delivers for fisheries is improving data quality and compliance, which can enable more efficient management measures and improved financial performance for industry. While theoretically sound, the evidence base for this in practice is still somewhat limited—the best evidence is probably from groundfish and crab fisheries in British Columbia. The community should investigate, validate, and communicate financial benefits to industry from improved fisheries management enabled by EM.
  - **Advocate for regulatory changes that can increase fisher flexibility as a result of improved accountability from EM.** For example, support adjustments to time and area closures that were previously enacted for species that are now covered with an output control, allow fishermen to fish multiple gears on a single trip, and develop individually targeted sanctions instead of fleet-wide closures.
  - **Develop alternative uses for EM data.** That includes expanding business analytics efforts like The Nature Conservancy’s app that aggregates Pacific groundfish fishermen’s data to help identify bycatch hotspots. Explore partnerships with data analytics firms (e.g., Gloucester Innovation) to develop value-added applications using EM data. Create a library of free or open source tools that fishermen and vessel owners can access to obtain better business analytics information derived from their EM data.
  - **Use EM in support of eco-certifications and FIPs.** For example, Luen Thai has supported EM in its longline tuna MSC certified fisheries to enable meeting the fisheries’ five percent observer coverage requirement. Explore strengthening of observer requirements in eco-certification criteria with MSC. Identify premium markets for fish caught with EM or sustainability claims validated with EM (e.g., FAD-free). Premium retailers, institutional buyers, major wholesalers, and food service establishments (e.g., Whole Foods, Marks & Spencer, premium hotels) should integrate EM into boat-to-plate origin stories. Further incorporate EM into advisory recommendations to major retailers in North America and Northern Europe and communicate to these companies how the current lack of on-the-water transparency leads to supply chain risks.

- **Target vertically integrated companies as early voluntary adopters of EM.** These companies are more likely to see the value of EM for improving operations, (e.g., improving product quality, improving on-board efficiency) and reducing the risk associated with at-sea operations (e.g.; labor concerns; IUU fishing; product shrinkage; transshipments). They also have the ability to push the requirement for EM onto their vessels. The early and voluntary adoption of EM within a handful of vertically integrated companies (e.g., Tri-Marine), and Thai Union’s commitment for 100 percent observer coverage on its longline fleet is a sign that this may be a ripe area to build bottom-up demand. The Keystone Dialogues, a collaboration of some of the worlds largest seafood producers and scientists committed to eliminating IUU and slavery, and to work towards full traceability in their supply chains, could be a venue to further socialize introduction of EM among major seafood companies.
- **Use EM to help prove compliance with import control requirements and incorporate into catch-to-plate traceability solutions.** For example, EM can bring greater transparency to mammal interactions, which may demonstrate compliance with US Marine Mammal Act import requirements. Consider an EM requirement for high-risk species identified through the Seafood Import Monitoring Program (SIMP) in the US, a reporting and recordkeeping requirements to prevent IUU or misrepresented seafood from entering US. Consider a similar EM requirement for high-risk commodities from flagged countries under the EU system.
- **Investigate potential with marine insurance providers to reduce premiums for vessels with EM.** EM can facilitate rapid claims processing and liability reduction, and perhaps in the longer term could allow fishermen to demonstrate lower risk and reduce premiums (e.g., akin to opt-in auto insurance trackers).
- **Support strategic testimonials from fishermen** – Experience has shown that fishermen who have experience with EM naturally have a much more favorable view of the technology. The reality of having cameras on board rarely matches up-front concerns, and there is no better group of people than other fishermen to carry this message about their experience with EM and the benefits it provides. Identifying industry champions and facilitating their strategic testimony is an approach that has been used in other fisheries management contexts (e.g., catch shares) and is an excellent tool to alleviate industry resistance to EM and full accountability. Identifying champions in regions facing significant fisher resistance may be an excellent place to apply this strategy (e.g., Northern EU, New England). Bringing fisher testimonials from regions that are a couple of steps ahead in terms of EM progress (e.g., US West Coast and Alaska) may also help build industry support.



## Near-Term Priorities to Advance EM

There is little doubt that absent significant additional interventions, EM will continue to make progress in rolling out incrementally over the next decade. Each country or region that tackles the questions about developing EM programs will learn from its own pilots and the slow accumulation of experience. But, this is not enough if we want to have comprehensive and reliable data that will enable sustainable management of a large swath of the world's fisheries.

The real challenge that we face today is how to accelerate that rate of change in order to help address global fisheries issues at scale, particularly in light of growing climate risks. We need to build more collective momentum so that each country or region can shortcut the growing pains of implementation and quickly identify best-in-class information. In tandem, the EM industry itself, which is hampered by a very limited market, can be encouraged to develop and implement next-generation solutions needed to drive down cost and enhance effectiveness.

In addition to the recommendations already presented to overcome the key barriers to broader EM uptake, we present a handful of near-term priorities for catalyzing growth of EM below.

### **1. Make EM in the Western and Central Pacific tuna longline fishery a shining example**

Much progress has been made with EM trials in the Pacific longline fishery and it is essential to push this work into broad implementation that can be publicized as a shining example of a successful EM program at scale delivering change on the water. Demonstrating the success of EM in one of the world's most important tuna fisheries would be hugely impactful. This work should include:

- 1) Continued piloting with a focus on troubleshooting key remaining challenges to widespread adoption (e.g., hook counts, cost and logistical challenges of maintenance).
- 2) Collaboration with FFA, SPC, WCPFC, and member states on EM program design and standard setting. Determine and advocate for optimal levels of coverage, video review rate, appropriate allocation of data collection to EM, observers, dockside monitoring, etc.
- 3) Advocacy and collaboration with FFA members to require EM as a condition of license for fishing in their EEZs and adjacent high seas.

### **2. Move EM trials in the New England multispecies fishery to full implementation**

The sector management system in New England continues to struggle due to a lack of accountability on the water. Years of trials and studies have investigated and tested the viability of EM in this fishery and it is time to make the jump to full-fledged implementation. This fishery has clear accountability needs, is in a high governance capacity region, and EM is the ideal tool to deliver the at-sea transparency this fishery needs for the sector program to succeed. Efforts should include:

- 1) Advocate for full accountability and EM through the amendment 23 process.
- 2) Cultivate industry champions for EM and support their strategic testimonials.
- 3) Continue to refine EM trials in the fishery and strengthen the evidence that EM is the ideal tool for the fishery's on-the-water data needs.

### **3. Advocate for implementation of EM in the EU**

The recently proposed control regulation for fisheries, which states that EM should be regionally applied to vessels to enforce the landing obligation on a risk-based assessment is a major opportunity to advance EM in the region. This high-level guidance is an important step but leaves wide latitude for member countries to define the degree that they will roll out EM. A major effort is needed to ensure that EM systems are mandated for vessels with a high risk of discards and that these requirements are actually implemented in the Specific Control and Inspection Programmes. A handful of organizations are actively advocating for strong EM requirements in the EU and these efforts should be further supported.

#### **4. Support regulatory roundtables and a non-partisan working group to provide technical guidance to newly implementing regions**

A handful of countries are about to move forward with broad implementation of EM (e.g., New Zealand and Chile). This is an excellent opportunity to host regulator roundtables or exchanges, bringing in the expertise of regulators from countries that are a bit further along the EM learning curve. For example, dialogues between Australia and New Zealand or the US and Chile could facilitate knowledge transfer. Providing support for more of this information exchange may help speed implementation in these new EM regions and help avoid the same pitfalls that other regions have faced. Ultimately, building a non-partisan EM working group could be an ongoing resource to support EM development processes around the globe. The Regulatory Assistance Project, which works on power sector issues, may be a useful analog to consider.

#### **5. Push for interoperability and performance standards**

EM cannot continue as a highly bespoke solution that locks in single vendors and stifles innovation. We believe it is important to try and push vendors to meet the demands of the EM customer base and to also work towards the development of performance and interoperability standards (e.g., standards that enable video coming off of any EM hardware system to be used by any EM review software, standards that enable easier integration with other data streams). These standards should ensure robust performance, but also allow for flexibility and technological advances. A key first step should be hosting an EM vendor and customer workshop to hash through key challenges (e.g., contracting, data privacy, performance standards). We also think that it may be the right time for a customer with significant market pull (e.g., NOAA) to develop performance/interoperability standards that can push for unbundling of EM services (e.g., equipment, review, storage).

#### **6. Demonstrate the seamless integrated monitoring solution of the future**

We need to bring fisheries monitoring into the 21st century, and a key step is to make this vision tangible. An integrated monitoring solution in a high-profile fishery that includes, EM, positional sensors, seamless electronic reporting, Global Fishing Watch, and/or other cutting-edge monitoring solutions should be developed and publicized broadly to encourage other fisheries to follow suit.

#### **7. Demonstrate EM in the world's largest fishery**

The Peruvian anchoveta fishery is an excellent candidate for EM. With high value, interest from industry, and at-sea monitoring needs that are well suited to EM (e.g., discarding) there is a great opportunity to demonstrate EM in one of the world's most iconic fisheries. This can serve as a beachhead for expanding the use of EM to other small-pelagic fisheries as well as in Latin America.

#### **8. Socialize EM with the next tier of markets**

EM is gaining a foothold in many regions (e.g., Canada, US, Australia, New Zealand, Western and Central Pacific), but efforts should get underway to socialize the technology in the next tier of target countries. This includes countries such as China and Japan that are actively considering broader use of output controls in their fisheries which will demand better on-the-water accountability, as well as other major fishing countries (e.g., Indonesia). These are some of the world's most important fishing countries, and if we are to realize a vision of sustainable fisheries worldwide their fisheries must realize greater transparency and accountability on the water. Socializing EM with key fisheries stakeholders in these regions is an important early step on the pathway to that goal.

## EM priorities for the next 3+ years

	NEXT 3 YEARS	3+ YEARS
<b>GEOGRAPHIC PRIORITIES</b>	<p><b>Build on existing momentum for EM in high-value and high-governance fisheries</b></p> <p><b>United States and Canada</b> – Continued rollout of EM in priority federally managed commercial fisheries (e.g., HMS, trawl, pelagics), and development of stronger national guidelines to streamline implementation.</p> <p><b>Australia</b> – Adoption of EM in the majority of Commonwealth fisheries.</p> <p><b>New Zealand</b> – Full implementation of EM mandate.</p> <p><b>Western and Central Pacific Fisheries Commission (WCPFC)</b> – Regulatory mandate for longline permits and implementation in the majority of Forum Fisheries Agency nations. Initial piloting of EM for purse seine vessels.</p> <p><b>EU</b> – Adoption of EM for high-risk vessels in select EU nations (e.g., Denmark, UK, Netherlands).</p> <p><b>N. Asia</b> – Pilot EM trials for domestic fisheries at scale in China, Japan, and Korea, tied to fisheries reform goals that demand comprehensive monitoring..</p> <p><b>Newly Industrialized Countries</b> – Pilot EM trials at scale for industrial-scale fisheries in major middle-income countries: Peru, Chile, Argentina, Mexico, Brazil. Further develop proof points of low-cost EM systems in small-scale fisheries (e.g., Indonesia, Mexico).</p>	<p><b>Expand into other globally important regions and fisheries</b></p> <p><b>United States and Canada</b> – Complete rollout of EM in federally managed commercial fisheries where EM is cost-effective, with initial implementation of EM solutions in charter recreational fisheries and select state fisheries.</p> <p><b>Australia</b> – Complete rollout of EM across all Commonwealth fisheries.</p> <p><b>WCPFC</b> – Expansion of EM mandate to all longline vessels, including the high seas. EM approved as an alternative to human observers in purse seine fisheries.</p> <p><b>Other Regional Fisheries Management Organizations (RFMOS)</b> – Expand longline EM implementation to other RFMOS, particularly the Inter-American Tropical Tuna Commission (IATTC), Indian Ocean Tuna Commission (IOTC), the International Commission for the Conservation of Atlantic Tuna (ICCAT), and CCAMLR.</p> <p><b>EU</b> – Implementation of EM across all medium- and high-risk vessels in Northern EU waters and for high-risk vessels in the Mediterranean.</p> <p><b>N. Asia</b> – EM adopted across multiple output-controlled fisheries in China, Japan, and Korea, informing further work in each country on the feasibility of fisheries reform.</p> <p><b>Newly Industrialized Countries</b> – EM used fishery-wide in largest fisheries (e.g., anchoveta) and high-risk gear types (e.g., trawl gear) in targeted middle-income countries. Low-cost EM systems in small-scale fisheries have demonstrated viability and is spreading across dozens of countries.</p>
<b>FISHERY TYPES</b>	<p><b>Implementation Focus</b></p> <ul style="list-style-type: none"> <li>• Passive gear fisheries (e.g., pelagic longline, pot and trap fisheries, gillnet)</li> <li>• Multispecies trawl fisheries (e.g., New Zealand inshore, New England groundfish, EU mixed trawl)</li> </ul>	<p><b>Implementation Focus</b></p> <ul style="list-style-type: none"> <li>• Passive gear fisheries (e.g., pelagic longline, pot and trap fisheries, gillnet)</li> <li>• Multispecies trawl fisheries (e.g., EU mixed trawl)</li> <li>• Purse seine fisheries (e.g., purse seine tuna, anchoveta)</li> </ul>

## EM priorities for the next 3+ years

	NEXT 3 YEARS	3+ YEARS
<b>MONITORING FUNCTIONS</b>	<p><b>Continued EM implementation for:</b></p> <ul style="list-style-type: none"> <li>• Catch handling (e.g., ensure no sorting prior to sampling, ensure only target species pass over flow scales)</li> <li>• Discard monitoring</li> <li>• Catch and bycatch enumeration</li> <li>• ETP interactions</li> <li>• Basic sensor data (location, temperature, time, etc.)</li> </ul> <p><b>Demonstrate EM capability for new functions:</b></p> <ul style="list-style-type: none"> <li>• Target species catch and bycatch estimation in high-volume purse seine and trawl fisheries</li> <li>• Transshipment monitoring</li> <li>• Labor practices</li> <li>• Automated species identification</li> </ul>	<p><b>Continued EM implementation for:</b></p> <ul style="list-style-type: none"> <li>• Catch handling</li> <li>• Discard monitoring</li> <li>• Catch and bycatch enumeration</li> <li>• ETP interactions</li> <li>• Basic sensor data (location, temperature, time, etc.)</li> <li>• Target species catch and bycatch estimation in high-volume trawl and purse seine fisheries</li> <li>• Transshipment monitoring</li> <li>• Labor practices</li> </ul> <p><b>Demonstrate EM capability for more complex functions in high-volume purse seine fisheries</b></p> <ul style="list-style-type: none"> <li>• Automated non-target species catch estimation</li> <li>• Discard species identification and estimation</li> </ul>
<b>TECHNOLOGY</b>	<ul style="list-style-type: none"> <li>• Software and AI advancements reduce review time by at least 50%.</li> <li>• Advance image recognition from R&amp;D phase to first commercial-scale rollouts.</li> <li>• Advance on-board processing and demonstrate initial proof points of cost-effective real-time data transfer.</li> <li>• Hardware costs drop 50% relative to today's prices.</li> </ul> <p><b>Trials</b></p> <ul style="list-style-type: none"> <li>• Catch estimation in purse seine fisheries</li> <li>• Species identification in low-volume fisheries (e.g., handline, fixed gear, recreational)</li> </ul>	<ul style="list-style-type: none"> <li>• Image recognition widely integrated into EM video review software to significantly reduce review time.</li> <li>• On-board processing and real-time data transfer are commercially viable in coastal fisheries, allowing for real-time fisheries management in applicable contexts.</li> <li>• Software and AI advancements reduce video review time by at least 90%.</li> <li>• Hardware costs are 75% lower than current levels.</li> <li>• Low-cost, small-scale fishery camera systems and sensor apparatus exist at &lt;\$500/boat.</li> </ul>
<b>NUMBER OF VESSELS WITH EM GLOBALLY</b>	5,000 (~15% of vessels >12m in high-governance regions)	25,000 (~6% of vessels >12m globally)



## Appendix A – Future EM Scenario Assumptions

The following table lays out the fisheries that have current EM programs or pilots and the estimated number of vessels with EM systems. The tables on the following two pages outline the fisheries and the number of vessels within those fisheries that install EM systems in the four future scenarios: baseline, expanded growth, new paradigm, and vision attained. These scenarios are not predictions of what will happen, but present different possibilities of what could happen and the underlying assumptions of which fisheries adopt EM and the overall growth of the tool. There is no comprehensive inventory of installed EM systems, so the list of current EM systems is unlikely complete, but it does include the vast majority of EM systems installed globally.

EXISTING EM SYSTEMS	
BC Hook and Line	200
BC Crab Area A	50
Quinnault Crab	25
Atlantic HMS	112
New England Groundfish	12
Herring and Mackerel Trawl	12
Hawaii Longline	19
West Coast Groundfish	45
Alaska Fixed Gear >40 ft	90
Alaska Pot Cod	30
EU Trials	82
Australia	75
New Zealand	20
Ghana	14
WCPFC	100
<b>TOTAL</b>	<b>886</b>

Main focus fisheries			Share of Vessels with EM Installed by Scenario (2028)				Number of Vessels with EM Installed by Scenario (2028)				
Target areas	Gear	# of vessels	Baseline	Expanded Growth	New Paradigm	Vision Attained	Baseline	Expanded Growth	New Paradigm	Vision Attained	
WCPFC	Longliners	2,500	25%	50%	50%	75%	625	1,250	1,875	2,500	2,500
New Brunswick Snow Crab	Trap	150	50%	100%	100%	100%	75	150	150	150	150
N. Europe (Vessels over 12m)	Multiple	7,250	5%	10%	10%	25%	363	725	1,813	3,625	3,625
Peru Anchoveta North Central (Industrial)	Purse Seine	554	50%	100%	100%	100%	277	554	554	554	554
Peru Anchoveta North Central (Semi Industrial)	Purse Seine	587	0%	50%	100%	100%	-	294	587	587	587
Alaska Pot Cod	Pot	109	50%	100%	100%	100%	55	109	109	109	109
Alaska Small boat fixed gear	Fixed Gear	523	25%	50%	75%	100%	131	262	392	523	523
Atlantic HMS	Longlines	112	100%	100%	100%	100%	112	112	112	112	112
Quinnault Crab	Trap	25	100%	100%	100%	100%	25	25	25	25	25
West Coast Groundfish	Multiple	97	100%	100%	100%	100%	97	97	97	97	97
New England Groundfish	Multiple	200	100%	100%	100%	100%	200	200	200	200	200
Atlantic Herring and Mackerel	Midwater Trawl	13	100%	100%	100%	100%	13	13	13	13	13
Alaska BSAI Non-Pollock Trawl	Trawl	24	50%	100%	100%	100%	12	24	24	24	24
Alaska Rockfish Trawl Catcher Vessels	Trawl	46	50%	100%	100%	100%	23	46	46	46	46
Alaska AFA Catcher Vessels	Trawl	83	50%	100%	100%	100%	42	83	83	83	83
WGOA Pollock Trawl	Trawl	42	50%	100%	100%	100%	21	42	42	42	42
Australia Commonwealth	Multiple	300	100%	100%	100%	100%	300	300	300	300	300
New Zealand	Multiple	1,172	40%	65%	75%	85%	469	762	879	996	996
Chile (Industrial Fleet)	Multiple	456	50%	100%	100%	100%	228	456	456	456	456
Hawaii Longline	Longliners	22	100%	100%	100%	100%	22	22	22	22	22
BC Hook and Line	Hook and Line	200	100%	100%	100%	100%	200	200	200	200	200
BC Crab	Trap	50	100%	100%	100%	100%	50	50	50	50	50
IOTC	Longliners	1,061	25%	50%	75%	100%	265	531	796	1,061	1,061
IATTC	Longliners	2,420	25%	50%	75%	100%	605	1,210	1,815	2,420	2,420
ICCAT	Longliners	3,728	25%	50%	75%	100%	932	1,864	2,796	3,728	3,728
Ghana	Purse Seine	14	100%	100%	100%	100%	14	14	14	14	14
CCAMLR	Multiple	46	50%	100%	100%	100%	23	46	46	46	46
<b>TOTAL</b>		<b>21,784</b>					<b>5,177</b>	<b>9,439</b>	<b>13,496</b>	<b>17,983</b>	

Next tier of target fisheries			Share of Vessels with EM Installed by Scenario (2028)				Number of Vessels with EM Installed by Scenario (2028)				
Target areas	Gear	# of vessels	Baseline	Expanded Growth	New Paradigm	Vision Attained	Baseline	Expanded Growth	New Paradigm	Vision Attained	
N. EU Small vessels	Multiple	36,840	0%	0%	5%	10%	-	-	1,842	3,684	3,684
S. EU Small Vessels	Multiple	33,000	0%	0%	2%	5%	-	-	660	1,650	1,650
S. Europe (Vessels >10 m)	Multiple	4,910	0%	0%	10%	25%	-	-	491	1,227	1,227
Gulf of Mexico Commercial Reef Fish	Multiple	284	10%	25%	50%	100%	28	71	142	284	284
South Atlantic Shapper Grouper	Multiple	200	10%	25%	50%	100%	20	50	100	200	200
Gulf of Mexico Shrimp	Trawl	1,150	0%	10%	25%	50%	-	115	288	575	575
South Atlantic Golden Crab	Trap	11	25%	50%	100%	100%	3	6	11	11	11
Gulf of Mexico charter/recreational reef fish	Hook and line	1,311	0%	5%	25%	50%	-	66	328	656	656
Other North American Vessels >12m	Multiple	8,348	0%	5%	10%	25%	-	417	835	2,087	2,087
Other Latin America Vessels >12m	Multiple	21,403	1%	2%	5%	10%	214	428	1,070	2,140	2,140
WCPFC Purse Seine	Purse Seine	226	25%	50%	75%	100%	57	113	170	226	226
ICCAT Purse Seine	Purse Seine	1,058	25%	50%	75%	100%	265	529	794	1,058	1,058
IATTC	Purse Seine	284	25%	50%	75%	100%	71	142	213	284	284
IOTC	Purse Seine	208	25%	50%	75%	100%	52	104	156	208	208
Indonesia Shapper	Bottom Set	1,500	1%	5%	20%	30%	15	75	300	450	450
<b>Total</b>		<b>110,733</b>					<b>724</b>	<b>2,116</b>	<b>7,398</b>	<b>14,740</b>	

Future expansion regions			Share of Vessels with EM Installed by Scenario (2028)				Number of Vessels with EM Installed by Scenario (2028)				
Aggressive Targets	Gear	# of vessels	Baseline	Expanded Growth	New Paradigm	Vision Attained	Baseline	Expanded Growth	New Paradigm	Vision Attained	
China	Multiple	200,000	0%	0%	1%	2%	-	-	2,000	4,000	4,000
Japan (<5GT)	Multiple	216,338	0%	0%	0%	1%	-	-	-	2,163	2,163
Japan (>5GT)	Multiple	26,291	0%	0%	2%	5%	-	-	526	1,315	1,315
Korea	Multiple	47,520	0%	0%	2%	5%	-	-	950	2,376	2,376
Philippines (Commercial Vessels)	Multiple	6,901	0%	0%	2%	5%	-	-	138	345	345
Philippines Municipal Vessels	Multiple	192,351	0%	0%	0%	2%	-	-	-	3,847	3,847
Indonesia (Inboard motor vessels) <5GT	Multiple	153,493	0%	0%	0%	2%	-	-	-	3,070	3,070
Indonesia (Inboard motor vessels) >5GT	Multiple	69,064	0%	0%	2%	5%	-	-	1,381	3,453	3,453
Indonesia (Outboard Motor)	Multiple	238,010	0%	0%	0%	0%	-	-	-	-	-
Taiwan (Powered <5GT)	Multiple	6,238	0%	0%	0%	0%	-	-	-	-	-
Taiwan (Powered >5GT excluding DMF)	Multiple	4,038	0%	0%	2%	5%	-	-	81	202	202
<b>Total</b>		<b>490,149</b>							<b>5,076</b>	<b>20,771</b>	

Number of Vessels with EM Installed by Scenario (2028)				
Baseline	Expanded Growth	New Paradigm	Vision Attained	
<b>TOTALS</b>	5,902	11,555	25,970	53,495

## Appendix B – EM Vendors and Service Providers

For many years, Archipelago Marine Research has been the main company providing EM products and services. With the recent growth of EM system installations, several new providers have entered the market and there are now about a dozen companies providing EM consulting services or making EM products (Table 2). This evolution of the market is indicative of a product that is in the midst of a transition from the development to growth stage of its life-cycle (Figure 11). Even with recent developments, the EM market remains small and fragmented—a back-of-the-envelope estimate suggests an overall market size on the order of \$10 million per year.<sup>131</sup> The small market and slow growth of the industry has limited the appetite of firms to make considerable investments in research or business development. Not surprisingly, essentially all EM suppliers have had to rely on significant revenue streams from business lines other than EM products and services (e.g., marine electronics, human observer services).

Table 2. EM equipment and service vendors

VENDOR	OVERVIEW
<b>Anchor Labs</b>	Anchor Labs is based in Copenhagen, and its systems have been used primarily in trials in the EU.
<b>Archipelago Marine Research</b>	Based in Victoria, British Columbia, AMR was the first vendor of EM systems and accounts for roughly half of the EM systems installed globally. Key markets include Canada, the US, and Australia. Recently, Archipelago transferred all of their EM products to Marine Instruments who, going forward, will develop and manufacture the systems while Archipelago will focus on the services of design, development, and implementation of EM programs.
<b>Digital Observer Services</b>	Digital Observer Services is an EM service provider and partners with Satlink to do video review and data processing.
<b>Ecotrust Canada</b>	Ecotrust has EM programs in place in Washington State’s Quinault crab fishery (~25 vessels) and the New England Groundfish fishery (~7 vessels).
<b>Flywire</b>	Based in Hawaii, Flywire is focused on low-cost systems that were designed to serve small-scale fisheries; it has systems in Mexico, Indonesia, Peru, and the US Gulf of Mexico.
<b>Integrated Monitoring</b>	A newcomer to EM, Integrated Monitoring’s founder brings expertise from the telecom and satellite communication sector. A key focus of this company is downscaling data on-board vessels for real-time data transfer.
<b>Marine Instruments</b>	Marine Instruments is focused on the design and manufacture of electronic equipment for the fisheries sector. In 2017, the company entered into a partnership with Archipelago and will focus on hardware design and manufacturing in this arrangement.
<b>Pelagic Data Systems</b>	Although not making camera systems, this company is on track to install around 10 thousand cellular-based location tracking devices on small-scale vessels in the developing world in the next 1-2 years.
<b>SatLink</b>	Based in Spain, SatLink works primarily with tuna vessels. The company has about 140 EM systems in the field, mostly in the Western Central Pacific.
<b>Saltwater, Inc.</b>	Saltwater has EM systems in a variety of fisheries and is the vendor for the US Atlantic HMS fishery as well as the Alaska pot cod and Alaska small-boat fixed gear fisheries.
<b>Shellcatch</b>	Shellcatch produces low-cost cellular-based video systems for small-scale developing-world vessels. The company has about 300 systems in place throughout Latin America, which are used primarily for marketing purposes.
<b>SnapIT</b>	Based in New Zealand, SnapIT has a foothold primarily in its domestic market. The company is currently focused on software enhancements to help with data processing and transmission.

<sup>131</sup> Based on an estimate of ~1 thousand vessels globally with an average amortized annual cost per system of \$10 thousand per vessel.

Figure 11. Stylized product life-cycle curve

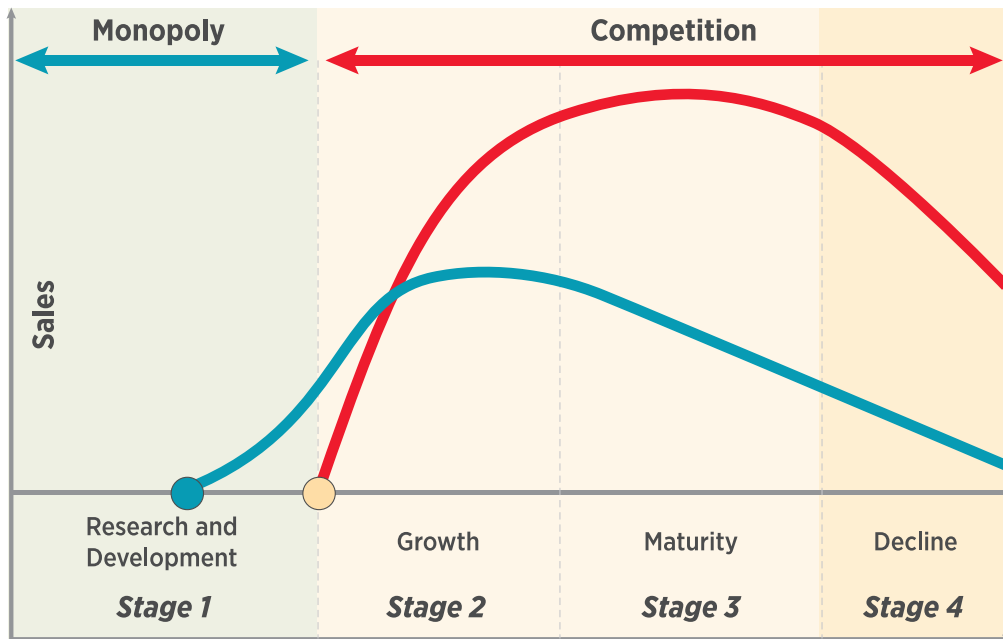

## Appendix C - Summary of Studies Comparing EM and Human Observers

Table 3. Summary of studies comparing EM and human observers (HO).<sup>132</sup>

FISHERY	YEAR OF TRIAL	KEY FINDINGS	ADDTL NOTES	REFERENCES
<b>West Coast IFQ Groundfish Fishery-Fixed Gear and Bottom Trawl in California Groundfish Collective</b>	2015-2016	No significant difference between EM and logbooks in weight of species discarded by vessels with fixed or trawl gear.	Fishermen were able to adapt to new catch-handling techniques that allowed for accurate EM estimates in a multispecies fishery.	Damrosch, Lisa. 2017. Summary Results from the California Groundfish Collective Exempted Fishing Permit Project 2015-2016.
<b>Australian Eastern Tuna and Billfish Longline Vessels</b>	2015	EM and HOs aligned within 2-12% for primary target species catch. Variation of up to 74% between EM and HO in part due to incomplete species identification of EM reviewer. 70% overall catch identification alignment between EM and HO.	EM drove a dramatic increase in discards reported in logbooks. Differences between EM and HO for discards in part due to incomplete species identification with EM.	Larcome, J., R. Noriega and T. Timmiss. Catch reporting under E-Monitoring in the Australian Pacific longline fishery. 2016.
<b>New England Multispecies Fishery Gillnet and Trawl</b>	2015	Close alignment between HO and EM for piece count (3%) and weight (5%) of total catch, close alignment of piece count by species for target species (1-5%), and weight by species for target species (0-4%).		Martins et al., 2016.
<b>Solomon Islands Tuna Longline Fleet</b>		High similarity between piece counts of total catch and species. Similarity in fish length estimates. Accurate identification of discard events. Species identification of non-target species only accurate at family level.	EM could not accurately assess the fate of discarded fish.	Hosken, M. et al. 2016. Report on the 2014 Solomon Islands Longline E-Monitoring.
<b>Pacific Hake Fishery Trawl Fixed Gear and Mothership/Catcher</b>	2012-2013	<b>Shoreside Hake</b> - Retained weights reported with HO and EM closely aligned, EM reported 2x the discard volume as HOs. <b>Mothership Hake</b> - Good alignment on retained catch. EM reported much higher discards, including five large discard events >2,000 lbs not reported by observers. <b>Fixed Gear</b> - Good alignment in piece counts but high variability in weights with EM because they did not use length boards. EM could only identify fish at the group level (e.g., flatfish, rockfish) which was insufficient for the IFQ. <b>Trawl</b> - Close alignment on retained and discarded halibut, sablefish, and lingcod. Inability of EM to identify to the species level for rockfish and thornyheads, especially for discards.	<b>Hake</b> - EM catch estimation in 2013 improved after getting vessel-specific net capacities. <b>Trawl</b> - On-board processes and camera angles made identifying catch and discard to the species level difficult with EM. For example, the location for discard sorting often moved and was far from camera.	Al-Humaidhi, A. and D. Colpo. Final Report: Electronic Monitoring Program: Review of the 2013 Season. 2014. Pacific States Marine Fisheries Commission. Ruiz, J. et al. 2015. Electronic Monitoring Trials in the Tropical Tuna Purse-Seine Fishery.

FISHERY	YEAR OF TRIAL	KEY FINDINGS	ADDTL NOTES	REFERENCES
<b>Tropical Tuna Purse Seine Fishery</b>	2012	EM and HO data were closely aligned for total catch per set. EM and HO were closely aligned for the total catch volume and volume of main target species. Significant variation existed for lower-volume species. There was also significant variation in reported shark volumes.	Conclusion of the study was that EM is a viable tool for monitoring fishing effort, set type, and total tuna catch, but limitations still exist for estimating species composition and monitoring bycatch.	Ruiz, J. et al. 2015. Electronic Monitoring Trials in the Tropical Tuna Purse-Seine Fishery.
<b>West Coast Groundfish Fishery Small Vessel Fixed Gear (Longline and Pot-and-Trap)</b>	2010	Very close alignment (1%) between HO and EM in count of total retained catch. No difference between logbooks and EM in count of total retained catch. Close alignment (1-3%) between HO and EM in count of target species. Less alignment with non-target species.		Bryan, J, Pria, M.J. and H. McElderry, 2011. Use of an Electronic Monitoring System to Estimate Catch on Groundfish Fixed Gear Vessels in Morro Bay California- Phase II. Unpublished report prepared for The Nature Conservancy by Archipelago Marine Research Ltd., Victoria British Columbia, Canada. 51 p.
<b>Hawaiian Pelagic Longline Fishery</b>	2009	Very close alignment between HO and EM in hook count (<1%), piece count of total retained catch (<1%), protected species interactions (0%), and piece count of target species (<2%). Less alignment for non-target species.	Discards were not estimated because they occurred outside the field of view of the camera.	McElderry, H., M.J. Pria, M. Dyas, R. McVeigh. 2010. A Pilot Study Using EM in the Hawaiian Longline Fishery.
<b>Danish Fishery, Mixed Fishery with Trawlers and Seiners</b>	2016	Overall video inspectors underestimated discards by 32%. Good alignment of cod discard estimates but inaccurate discard estimates of other species.	On-board handling procedures drove much of the variation (e.g., dirty cameras, fishermen blocking view of camera, and fish being discarded before reaching the camera's field of vision.	L. Mortensen et al. 2016. Effectiveness of fully documented fisheries to estimate discards in a participatory research scheme.
<b>Tropical Tuna Purse Seine Fishery</b>	2016	Alignment between EM and HO within 5% for catch per set. On a per-trip basis, the EM and HO estimates of total catch, discards, fishing effort (number of sets), fishing mode, and bycatch of major species were very similar. Significant variation in estimates for shark catch and species estimation with noted variance between bigeye and skipjack.		Monteagudo, J.P. et al. 2015. Preliminary study about the suitability of an electronic monitoring system to record scientific and other information from the tropical tuna purse seine fishery. SCRS/2014/132. Collect. Vol. Sci. Pap. ICCAT 71: 440-459.
<b>Australian Northern Prawn Fishery</b>	2010-2011	EM identified prawns in discards 75% of the time HOs did, and all species identification 90% of the time. EM missed several interactions with sea snakes, which likely happened out of camera view.	Project required on-board handling procedures to assist EM review.	Piasente, et al. 2012. Assessing discards using onboard electronic monitoring in the Northern Prawn Fishery.



FISHERY	YEAR OF TRIAL	KEY FINDINGS	ADDTL NOTES	REFERENCES
<b>Australian Eastern Tuna and Billfish Fishery</b> <i>Longline</i>	2009-2010	Overall 70.7% match at species level between EM and HOs. Piece counts for retained catch aligned within 1.6%. Significant difference in released catch (180.7%). One seabird and one turtle interaction out of nine total were missed by the EM analyst.	Familiarity of EM reviewers (who were based in Canada) with species in Australian fishery was identified as a source of error.	Piasente, et al. 2011. Electronic onboard monitoring pilot project for the Eastern Tuna and Billfish Fishery.
<b>Peru</b> <i>Small-scale gillnet vessels</i>	2015-2016	9 of 12 target elasmobranchs were identified with EM at 90% or greater alignment with HO. The other 3 had alignment of 85%,82%, and 65%. EM identified bycatch with 50% alignment for turtles, 80% for cetaceans, and 100% for pinnipeds.	The majority of deviations between cameras and HOs were attributed to camera specifications that were set to minimize data storage and transmission requirements. Study was using ShellCatch EM system.	Bartholomew, et al. 2018. Remote electronic monitoring as a potential alternative to on-board observers in small-scale fisheries.
<b>New Zealand</b> <i>Demersal and Pelagic Longline Fisheries</i>	2006-2007	Human observers identified 9 protected species interactions, but only two of these were in the field of view of EM. The other seven were deck landings or contact with fishing gear where the species was not hooked/entangled and brought into camera view. EM was able to identify the two ETP interactions where the species was entangled and brought into view.	EM initially missed one turtle interaction, but this was easily seen on review of the video.	McElderry, et al. 2008. Electronic monitoring to assess protected species interactions in New Zealand longline fisheries: a pilot study

## Appendix D - EM Data Lifecycle & System Design Considerations

EM can provide large amounts of data at fine scales. In developing an EM program, design choices affect the type and amount of data collected, which in turn affects cost and the utility of the program for management. Understanding how and why the data will flow through the EM system can also affect industry acceptance of the program, and which vendors to engage. Table 4 below identifies some key issues at each step of the data lifecycle; data issues specific to each fishery and region may emerge during EM development if program designers engage a range of stakeholders.

Table 4. Key data lifecycle steps and design considerations

<b>DATA LIFECYCLE STEP</b>	<b>KEY ISSUES AND DESIGN CONSIDERATIONS</b>
<b>Data Collection</b>	<p>Hardware can be leased from vendors, owned by fishers, or owned/leased by regulatory agencies. An EM system designed for compliance with catch and discard rules may have fewer components than one gathering oceanographic data for scientists or monitoring data for buyers and suppliers (e.g. tracking human rights issues or hold conditions that affect seafood quality).</p> <p>If agencies own the hardware, they may bear the full costs of installation and maintenance but can also move them around on boats and add components as needed. Agencies could specify a minimum required system configuration that fishers, buyers, and vendors could add to if they see value in tracking other data.</p>
<b>Transmission</b>	<p>On-board data may be mailed to reviewers on physical hard drives, or transmitted via satellite, cellular, or wireless connection in port. Some vendors use technology to clip data to reduce file size (e.g. not transmitting video or recording at lower resolution when a boat isn't actively fishing).</p> <p>No matter how data is transmitted, it needs to be secure with appropriate levels of encryption and tamper-resistance. Back-ups of transmitted data should be stored safely, especially if raw video is redacted prior to transmission to reviewers.</p>
<b>Review &amp; Extraction</b>	<p>Many EM vendors include video review in their services and provide "extracted" data (e.g. number and species of fish, catch location) as tables. Review could also be done by agencies or fishing associations, with proper training and oversight.</p> <p>Raw video contains the largest amount of data and also poses the most privacy issues, as it may include faces and personally identifying information. Whoever receives or holds the raw footage needs to comply with legal restrictions on privacy and confidentiality. Tabular data also needs to meet privacy and confidentiality standards, although these data are easier to aggregate and redact.</p>
<b>Access &amp; Sharing</b>	<p>In some EM systems, fishers can view video as it's being recorded on-board but not retain copies of their video for future use. Vendors or agencies could provide fisher access once video is reviewed and validated, or vendors could provide analyzed reports back to fishers to meet business requirements.</p> <p>If video and extracted data need to be available for both compliance and science needs, vendors and agencies need to set up data systems that provide access to a range of staff, possibly restricting data fields based on staff qualifications. In countries with public right-of-access rules, EM systems will also need to allow for public requests for images or extracted data.</p>
<b>Storage &amp; Deletion</b>	<p>Data need to be stored long enough to meet legal requirements and could be stored by the government, vendors, or fishers. Large video files may cost more to store, especially if they need to be accessed frequently. Stored data can be hacked or leaked, so EM programs need to balance the need for legal records with the risks and expenses of data preservation. be the main vendor to meet the country's policy mandate for EM. The company is currently focused on software enhancements to help with data processing and streaming.</p>

## REFERENCES

- <sup>1</sup> Mark Zimring and Mike Sweeney, The Nature Conservancy
- <sup>2</sup> Matthew Elliott and Mark Michelin, California Environmental Associates
- <sup>3</sup> The World Bank. "The Sunken Billions Revisited: Progress and Challenges in Global Marine Fisheries." (2017)
- <sup>4</sup> Ibid.
- <sup>5</sup> Archipelago Marine Research. [www.archipelago.ca/fisheries-monitoring/electronic-monitoring/](http://www.archipelago.ca/fisheries-monitoring/electronic-monitoring/). Accessed May 2018.
- <sup>6</sup> Ibid.
- <sup>7</sup> Ecotrust Canada. "Electronic Monitoring in BC's Area A Crab Fleet." <http://ecotrust.ca/project/electronic-monitoring-in-bcs-area-a-crab-fleet/>. Accessed August, 2018.
- <sup>8</sup> 12 meters is used as a cutoff to estimate fishing vessels that are well-suited for EM. Length is being used as a proxy for fisheries with significant landed value and well-developed management systems which are enabling conditions for EM. This is a somewhat arbitrary cutoff, but one for which there is globally reported data.
- <sup>9</sup> FAO. "State of Fisheries and Aquaculture: Contributing to Food Security and Nutrition for All." (2016).
- <sup>10</sup> NOAA. "National Observer Program FY 2013 Annual Report National Marine Fisheries Service" (2014).
- <sup>11</sup> European Commission. "Proposal for a REGULATION OF THE EUROPEAN PARLIAMENT AND OF THE COUNCIL amending Council Regulation (EC) No 1224/2009, and amending Council Regulations (EC) No 768/2005, (EC) No 1967/2006, (EC) No 1005/2008, and Regulation (EU) No 2016/1139 of the European Parliament and of the Council as regards fisheries control." (2018).
- <sup>12</sup> EMinformation.com. Accessed June 2018.
- <sup>13</sup> Ministry for Primary Industries. "Integrated Electronic Monitoring and Reporting System - Regulatory Impact Statement." (2017).
- <sup>14</sup> Gilman, Eric. "Meeting the objectives of fisheries observer programs through electronic monitoring." (Unpublished)
- <sup>15</sup> Dalskov et al. "Danish Catch Quota Management trials - application and results." (2012).
- <sup>16</sup> Sandeman. "North Sea Cod Catch Quota Trials: Final Report 2015." (2016).
- <sup>17</sup> Dalskov et al. "Danish Catch Quota Management trials - application and results." (2012).
- <sup>18</sup> ABARES. "Catch Reporting under E-monitoring in the Australian Pacific longline fishery." (2016).
- <sup>19</sup> Confidential interviewee.
- <sup>20</sup> MRAG. "Towards the Quantification of Illegal, Unreported and Unregulated (IUU) Fishing in the Pacific Islands Region." (2016).
- <sup>21</sup> WCPFC. "WCPFC Record of Fishing Vessels." Accessed July, 2018.
- <sup>22</sup> Assumes an amortized cost of 10K per vessel.
- <sup>23</sup> MRAG. "Towards the Quantification of Illegal, Unreported and Unregulated (IUU) Fishing in the Pacific Islands Region." (2016).
- <sup>24</sup> NOAA. [https://www.greateratlantic.fisheries.noaa.gov/mediacenter/2018/01/25\\_at-sea\\_monitoring\\_2018\\_coverage\\_levels.html](https://www.greateratlantic.fisheries.noaa.gov/mediacenter/2018/01/25_at-sea_monitoring_2018_coverage_levels.html). Accessed June, 2018.
- <sup>25</sup> The Maritime Executive. "NOAA Shuts Down 22 Fishing Boats over 'Codfather' Scandal." (2017).
- <sup>26</sup> Bever, Fred. "'Codfather' Scandal Shuts Out Boats From Cod, Flounder Fisheries." *Maine Public*. (2017).
- <sup>27</sup> Ibid.
- <sup>28</sup> Mullin, Matt. "It's Time to Take New England's Groundfish Fishery Out of the Dark." EDF (2015).
- <sup>29</sup> Associated Press. "Scientists: Cod population in New England drops 80 percent." (2017).
- <sup>30</sup> NOAA. "Looking Forward to Looking Back: Electronic Monitoring in New England Groundfish: A Message from John Bullard, Regional Administrator for NOAA Fisheries Greater Atlantic Region." (2017).
- <sup>31</sup> Ibid.
- <sup>32</sup> Confidential interviewee.
- <sup>33</sup> NOAA. "Second National Electronic Monitoring Workshop." (2016).
- <sup>34</sup> Gerner, Mike. Australian Fisheries Management Authority. Personal communication. June 2018.
- <sup>35</sup> Pacific Fisheries Management Council. "West Coast Groundfish Trawl Catch Share Program Five-year Review - Draft." (2017).
- <sup>36</sup> Pacific Fisheries Management Council. "Decision Summary Document Pacific Fishery Management Council April 5-11, 2018." (2018).
- <sup>37</sup> Wilcox, Meg. "The Future of Fishing is Big Data and Artificial Intelligence." (2018).
- <sup>38</sup> NOAA, "Gulf of Maine Atlantic Cod 2017 Assessment Update Report." (2017).
- <sup>39</sup> WBUR Radio Boston, 2017. "What's Happening to Cod in New England."
- <sup>40</sup> Ibid.
- <sup>41</sup> Wilcox, Meg. "The Future of Fishing is Big Data and Artificial Intelligence." (2018).
- <sup>42</sup> NOAA. "Second National Electronic Monitoring Workshop." (2016).
- <sup>43</sup> At Sea Processors Association. <https://www.atsea.org>. Accessed June, 2018.
- <sup>44</sup> Marine Stewardship Council. "The MSC at 20. Wild. Certified. Sustainable. Annual Report 2016 - 17."
- <sup>45</sup> Marine Stewardship Council. "Scoring a Fishery - P2 Species." MSC CAB Training (2014).
- <sup>46</sup> Levitt, Tom. "Our love of cheap seafood is tainted by slavery: how can it be fixed?" *The Guardian*. (2016).
- <sup>47</sup> Confidential interviewee.
- <sup>48</sup> Sterling et al. "Assessing the Value and Role of Seafood Traceability from an Entire Value-Chain Perspective." (2015).
- <sup>49</sup> Associated Press. "An AP investigation helps free slaves in the 21st century." <https://www.ap.org/explore/seafood-from-slaves/>. Accessed August, 2018.
- <sup>50</sup> Daily Mail. "22 Years a Slave." (2015).
- <sup>51</sup> Chantavanich, et al. "Under the shadow: Forced labour among sea fishers in Thailand." (2016).
- <sup>52</sup> Ibid.
- <sup>53</sup> Verité, "Recruitment Practices and Migrant Labor Conditions in Nestlé's Thai Shrimp Supply Chain" (2015).
- <sup>54</sup> McDowell et al. "AP Investigation: Fish billed as local isn't always local." (2018).
- <sup>55</sup> Satlink. "Human Conditions on Board." Poster presented at the IFOMC conference. (2018).
- <sup>56</sup> Seafood Source. "Greenpeace campaign ends as Thai Union agrees to improve fishing and labor practices." (2017).
- <sup>57</sup> CCAMLR. <https://www.ccamlr.org/en/compliance/catch-documentation-scheme-cds>. Accessed August, 2018.
- <sup>58</sup> NOAA. "Fish and Fish Product Import Provisions of the Marine Mammal Protection Act." (2016).
- <sup>59</sup> NOAA. "Second National Electronic Monitoring Workshop." (2016).
- <sup>60</sup> There is debate about what a sufficient level of observer coverage is for the fleet with most arguing that 5 percent is too low. A large majority of experts are coalescing around 20 percent coverage as a minimum assuming the coverage is well-distributed.
- <sup>61</sup> Confidential interviewee.
- <sup>62</sup> NOAA. "Second National Electronic Monitoring Workshop." (2016).
- <sup>63</sup> Faunce et al. "Deployment and Observer Effects as Evidenced from Alaskan Groundfish Landings Reports." (2009).
- <sup>64</sup> Porter Environmental Law Institute. "Fisheries Observers as Enforcement Assets: Lessons from the North Pacific." *Marine Policy*. (2010).
- <sup>65</sup> Demarest, Chad. "Demonstrated observer effects by vessels in the Northeast US groundfish fishery." Presentation to the IFOMC (2018).
- <sup>66</sup> Gillman, E. "Standardized catch and survival rates, and

- effect of a ban on shark retention, Palau pelagic longline fishery.” (2016).
- <sup>67</sup> National Marine Fisheries Service, Office of Law Enforcement. “Frequency of Safety and Harassment Violations Types and the Factors that Impede Disclosure.” Poster at the International Fisheries Observer and Monitoring Conference. (2018).
- <sup>68</sup> NOAA. “Law Enforcement Office closes a successful investigation after numerous observers filed complaints against an Alaskan-based vessel” (2017).
- <sup>69</sup> Heinz et al. “Review of NOAA Fisheries Safety Policies and Procedures in US Regional and International Observer Programs.” (2017).
- <sup>70</sup> Watling, Jack. “Fishing observers ‘intimidated and bribed by EU crews.’” (2012).
- <sup>71</sup> Marine Resources Assessment Group (MRAG). “Observer Programs: best practice funding options and North Sea case study.” (2006).
- <sup>72</sup> NOAA. “Second National Electronic Monitoring Workshop.” (2016).
- <sup>73</sup> Ibid.
- <sup>74</sup> McElderry, H. “At-Sea Observing Using Video-Based Electronic Monitoring.” (2008).
- <sup>75</sup> Damrosch, L. “Electronic Monitoring in the West Coast Groundfish Fishery.” (2017).
- <sup>76</sup> Al Humaidhi et al. “Final Report Electronic Monitoring Program: Review of the 2013 Season.” (2014).
- <sup>77</sup> Confidential interviewee.
- <sup>78</sup> Gilman, E. “Meeting the objectives of fisheries observer programs through electronic monitoring.” (2018) DRAFT.
- <sup>79</sup> Ibid.
- <sup>80</sup> Confidential interviewee.
- <sup>81</sup> McElderry, H. “At sea observing using video-based electronic monitoring.” (2008).
- <sup>82</sup> Confidential interviewee.
- <sup>83</sup> NOAA. <https://www.fisheries.noaa.gov/national/fisheries-observers/electronic-monitoring>. Accessed June 2018.
- <sup>84</sup> Costello, C. “Country-Level Costs vs. Benefits of Improved Fishery Management.” (2015).
- <sup>85</sup> Sylvia, et al. “Challenges, Opportunities, and Costs of Electronic Fisheries Monitoring.” (2016)
- <sup>86</sup> Gilman, E. “Meeting the objectives of fisheries observer programs through electronic monitoring.” (2018) DRAFT.
- <sup>87</sup> Brannan. “An Independent Review of: A Preliminary Cost Comparison of At-sea Monitoring and Electronic Monitoring for a Hypothetical Groundfish Sector Prepared for: ECS Federal, LLC and the National Ocean and Atmospheric Administration.” (2015).
- <sup>88</sup> NOAA. “A Cost Comparison of At-Sea Observers and Electronic Monitoring for a Hypothetical Midwater Trawl Herring/Mackerel Fishery.” (2015).
- <sup>89</sup> National Marine Fisheries Service. “Regional Electronic Technology Implementation Plan: April 2017 West Coast Update.” (2017).
- <sup>90</sup> Ibid.
- <sup>91</sup> NOAA. “A Preliminary Cost Comparison of At Sea Monitoring and Electronic Monitoring for a Hypothetical Groundfish Sector” (2015).
- <sup>92</sup> NOAA. “National Observer Program: Second National Electronic Monitoring Workshop Transcripts, Video Links, and Program Summaries.” (2016).
- <sup>93</sup> Archipelago Marine Research. “Monitoring the Area A crab fishery.”
- <sup>94</sup> Sylvia, et al. “Challenges, Opportunities, and Costs of Electronic Fisheries Monitoring.” (2016).
- <sup>95</sup> McElderry, Howard. Personal communication. May 2018.
- <sup>96</sup> NOAA. “A Preliminary Cost Comparison of At Sea Monitoring and Electronic Monitoring for a Hypothetical Groundfish Sector.” (2015).
- <sup>97</sup> Ministry of Primary Industry, New Zealand. “Integrated Electronic Monitoring and Reporting System: Regulatory Impact Statement.” (2017).
- <sup>98</sup> The Nature Conservancy. “TNC-RMI Cooperative Pelagic Longline EM Project End of Contract Summary Report.” (2018). Unpublished.
- <sup>99</sup> National Marine Fisheries Service. “Regulatory Impact Review and Initial Regulatory Flexibility Analysis for the Regulatory Amendment to the Pacific Coast Groundfish Fishery Management Plan to Implement an Electronic Monitoring Program in the Pacific Whiting Mothership Catcher Vessel and in the Shorebased Groundfish IFQ Fishery.” (2016).
- <sup>100</sup> NOAA. “A Preliminary Cost Comparison of At Sea Monitoring and Electronic Monitoring for a Hypothetical Groundfish Sector.” (2015).
- <sup>101</sup> Ibid.
- <sup>102</sup> National Marine Fisheries Service. “Regional Electronic Technology Implementation Plan: April 2017 West Coast Update.” (2017).
- <sup>103</sup> NOAA. “Second National Electronic Monitoring Workshop.” (2017).
- <sup>104</sup> World Wide Fund for Nature (WWF). “Electronic Monitoring in Fisheries Management.” (2015).
- <sup>105</sup> NOAA. “Second National Electronic Monitoring Workshop.” (2017).
- <sup>106</sup> The Nature Conservancy. “TNC-RMI Cooperative Pelagic Longline EM Project: End of Contract Summary Report.” (2018).
- <sup>107</sup> Sylvia, et al. “Challenges, Opportunities, and Costs of Electronic Fisheries Monitoring.” (2016).
- <sup>108</sup> Confidential interviewee.
- <sup>109</sup> NOAA. “Industry Funded Monitoring, An Omnibus Amendment to the Fishery Management Plans of the Mid Atlantic and New England Fishery Management Council.” (2016).
- <sup>110</sup> Ministry for Primary Industries, New Zealand. “Integrated Electronic Monitoring and Reporting System.” (2016).
- <sup>111</sup> Confidential interviewee.
- <sup>112</sup> Wang et al. “Cloud and Machine Learning Technologies for Electronic Monitoring Data Processing and Analysis.” (2017).
- <sup>113</sup> Hwang, Jenq-Neng. Personal communication. April, 2018.
- <sup>114</sup> Hwang, et al. “Chute Based Automated Fish Length Measurement and Water Drop Detection.” (2016).
- <sup>115</sup> Alaska Fisheries Science Center. “AFSC Observer Program’s EM Innovation Project: Progress Report for 2016.” (2016).
- <sup>116</sup> Wilcox, Meg. “The future of fishing is big data and artificial intelligence.” (2018).
- <sup>117</sup> French et al. “Convolutional Neural Networks for Counting Fish in Fisheries Surveillance Video.” (2015).
- <sup>118</sup> Kilburn, R. “Scottish Experience in the Use of CCTV Systems for Scientific Data Collection.” Presentation at the International Fisheries Observer and Monitoring Conference (2018).
- <sup>119</sup> Gilman, E. “Meeting the objectives of fisheries observer programs through electronic monitoring.” (2018).
- <sup>120</sup> Confidential interviewee.
- <sup>121</sup> Confidential interviewee.
- <sup>122</sup> NOAA. “National Observer Program: Second National Electronic Monitoring Workshop Transcripts, Video Links, and Program Summaries.” (2016).
- <sup>123</sup> CapLog Group. “Electronic Monitoring of Commercial Fishing.” (2017). Unpublished.
- <sup>124</sup> The Nature Conservancy. “Electronic Monitoring Program Toolkit: A Guide for Designing and Implementing Electronic Monitoring Programs.” (2018).
- <sup>125</sup> Confidential communication.
- <sup>126</sup> Plet-Hansen, et al. “Remote electronic monitoring and the landing obligation – some insights into fishermen’ and fishery inspectors’ opinions.” (2017).
- <sup>127</sup> Sylvia, et al. “Challenges, Opportunities, and Costs of Electronic Fisheries Monitoring.” (2016).
- <sup>128</sup> McElderry, et al. “Evaluation of Monitoring and Reporting Needs for Groundfish Sectors in New England.” (2008).
- <sup>129</sup> Confidential interviewee.
- <sup>130</sup> NOAA. “Second National Electronic Monitoring Workshop.” (2017).
- <sup>131</sup> Based on an estimate of -1 thousand vessels globally with an average amortized annual cost per system of \$10 thousand per vessel.
- <sup>132</sup> Table based on data from CapLog Group, 2017. “Electronic Monitoring of Commercial Fishing: Overview of Global Industry and Market.”

## BIBLIOGRAPHY

1. ABARES. "Catch Reporting under E-monitoring in the Australian Pacific longline fishery." 2016.
2. Alaska Fisheries Science Center. "AFSC Observer Program's EM Innovation Project: Progress Report for 2016." 2016.
3. Al-Humaidhi, A., D. Colpo. "Final Report: Electronic Monitoring Program: Review of the 2013 Season". Pacific States Marine Fisheries Commission (2014).
4. Archipelago Marine Research. "Monitoring the Area A crab fishery." Accessed June 2018. <http://www.archipelago.ca/case-studies/area-a-crab-fishery/>
5. Archipelago Marine Research. Accessed May 2018. [www.archipelago.ca/fisheries-monitoring/electronic-monitoring/](http://www.archipelago.ca/fisheries-monitoring/electronic-monitoring/).
6. Associated Press. "An AP investigation helps free slaves in the 21st century." Accessed August, 2018. <https://www.ap.org/explore/seafood-from-slaves/>.
7. Associated Press. "Scientists: Cod population in New England drops 80 percent." 2017.
8. At Sea Processors Association. Accessed June, 2018. <https://www.atsea.org>.
9. Bartholomew, et al. "Remote electronic monitoring as a potential alternative to on-board observers in small-scale fisheries". Biological Conservation (2018)
10. Bever, Fred. "'Codfather' Scandal Shuts Out Boats From Cod, Flounder Fisheries." Maine Public. 2017.
11. Brannan. "An Independent Review of: A Preliminary Cost Comparison of At-sea Monitoring and Electronic Monitoring for a Hypothetical Groundfish Sector Prepared for: ECS Federal, LLC and the National Ocean and Atmospheric Administration." NOAA. 2015.
12. Bryan, J, Pria, M.J. and H. McElderry. "Use of an Electronic Monitoring System to Estimate Catch on Groundfish Fixed Gear Vessels in Morro Bay California- Phase II". Unpublished report prepared for The Nature Conservancy by Archipelago Marine Research Ltd. 2011.
13. CapLog Group. "Electronic Monitoring of Commercial Fishing." Unpublished. 2017.
14. CCAMLR. Accessed August, 2018. <https://www.ccamlr.org/en/compliance/catch-documentation-scheme-cds>.
15. Chantavanich, et al. "Under the shadow: Forced labour among sea fishers in Thailand." Marine Policy (2016).
16. Cliff White. "Greenpeace campaign ends as Thai Union agrees to improve fishing and labor practices." Seafood Source. 2017.
17. Costello, C. "Country-Level Costs vs. Benefits of Improved Fishery Management." Oceans Prosperity Roadmap (2015).
18. Daily Mail. "22 Years a Slave." 2015.
19. Dalskov et al. "Danish Catch Quota Management trials - application and results." DTU Aqua (2012).
20. Damrosch, L. "Summary Results from the California Groundfish Collective Exempted Fishing Permit Project 2015-2016." 2017
21. Damrosch, L. "Electronic Monitoring in the West Coast Groundfish Fishery." Eminformation.com (2017).
22. Demarest, Chad. "Demonstrated observer effects by vessels in the Northeast US groundfish fishery." Presentation to the IFOMC (2018).
23. Ecotrust Canada. "Electronic Monitoring in BC's Area A Crab Fleet." Accessed August, 2018. <http://ecotrust.ca/project/electronic-monitoring-in-bcs-area-a-crab-fleet/>.
24. European Commission. "Proposal for a REGULATION OF THE EUROPEAN PARLIAMENT AND OF THE COUNCIL amending Council Regulation (EC) No 1224/2009, and amending Council Regulations (EC) No 768/2005, (EC) No 1967/2006, (EC) No 1005/2008, and Regulation (EU) No 2016/1139 of the European Parliament and of the Council as regards fisheries control." (2018).
25. FAO. "State of Fisheries and Aquaculture: Contributing to Food Security and Nutrition for All." (2016).
26. Faunce et al. "Deployment and Observer Effects as Evidenced from Alaskan Groundfish Landings Reports." NOAA (2009).
27. French et al. "Convolutional Neural Networks for Counting Fish in Fisheries Surveillance Video." Conference: Workshop on Machine Vision of Animals and their Behavior (2015).
28. Gerner, Mike. Australian Fisheries Management Authority. Personal communication. June 2018.
29. Gillman, E. "Standardized catch and survival rates, and effect of a ban on shark retention, Palau pelagic longline fishery." Aquatic conversation (2016).
30. Gilman, E. "Meeting the objectives of fisheries observer programs through electronic monitoring." (2018).
31. Heinz et al. "Review of NOAA Fisheries Safety Policies and Procedures in US Regional and International Observer Programs." NOAA (2017).
32. Hosken, M. et al. "Report on the 2014 Solomon Islands Longline E-Monitoring." 2016
33. Hwang, et al. "Chute Based Automated Fish Length Measurement and Water Drop Detection." NOAA (2016).
34. Hwang, Jeng-Neng. Personal communication. April, 2018.
35. Kilburn, R. "Scottish Experience in the Use of CCTV Systems for Scientific Data Collection." Presentation at the International Fisheries Observer and Monitoring Conference (2018).
36. Larcome, J., R. Noriega and T. Timmiss. "Catch reporting under E-Monitoring in the Australian Pacific longline fishery". Western and Central Pacific Fisheries Commission, Second E-Reporting and E-Monitoring Intersessional Working Group Meeting (2016).
37. Levitt, Tom. "Our love of cheap seafood is tainted by slavery: how can it be fixed?" The Guardian. October 2016.
38. Marine Resources Assessment Group (MRAG). "Observer Programs: best practice funding options and North Sea case study." 2006.
39. Marine Stewardship Council. "Scoring a Fishery - P2 Species." MSC CAB Training (2014).
40. Marine Stewardship Council. "The MSC at 20. Wild. Certified. Sustainable. Annual Report 2016 - 17."
41. Martins, et al. "EM Audit Report. EM Implementation Team Meeting." 2015.
42. McDowell, et al. "AP Investigation: Fish billed as local isn't always local." 2018.
43. McElderry, et al. "Electronic monitoring to assess protected species interactions in New Zealand longline fisheries: a pilot study." 2008
44. McElderry, et al. "Evaluation of Monitoring and Reporting Needs for Groundfish Sectors in New England." 2008.
45. McElderry, H. "At sea observing using video-based electronic monitoring." 2008.
46. McElderry, H., M.J. Pria, M. Dyas, R. McVeigh. "A Pilot Study Using EM in the Hawaiian Longline Fishery." 2010.
47. McElderry, Howard. Personal communication. May 2018.
48. Ministry for Primary Industries, New Zealand. "Integrated Electronic Monitoring and Reporting System." 2016.
49. Ministry of Primary Industry, New Zealand. "Integrated Electronic Monitoring and Reporting System: Regulatory Impact Statement." 2017.
50. Monteagudo, J.P. et al. "Preliminary study about the suitability of an electronic monitoring system to record scientific and other information from the tropical tuna purse seine fishery." ICCAT (2015).
51. Mortensen, L. et al. "Effectiveness of fully documented fisheries to estimate discards in a participatory research scheme." Fisheries Research (2016)
52. MRAG. "Towards the Quantification of Illegal, Unreported and Unregulated (IUU) Fishing in the Pacific Islands Region." 2016.
53. Mullin, Matt. "It's Time to Take New England's Groundfish Fishery Out of the Dark." EDF 2015.
54. National Marine Fisheries Service, Office of Law Enforcement. "Frequency of Safety and Harassment Violations Types and the Factors that Impede Disclosure." Poster at the International Fisheries Observer and Monitoring Conference. 2018.
55. National Marine Fisheries Service. "Regional Electronic Technology Implementation Plan: April 2017 West Coast Update." 2017.



56. National Marine Fisheries Service. "Regulatory Impact Review and Initial Regulatory Flexibility Analysis for the Regulatory Amendment to the Pacific Coast Groundfish Fishery Management Plan to Implement an Electronic Monitoring Program in the Pacific Whiting Mothership Catcher Vessel and in the Shorebased Groundfish IFQ." 2016.
57. NOAA. "Gulf of Maine Atlantic Cod 2017 Assessment Update Report." 2017.
58. NOAA. "A Preliminary Cost Comparison of At Sea Monitoring and Electronic Monitoring for a Hypothetical Groundfish Sector." 2015.
59. NOAA. "Fish and Fish Product Import Provisions of the Marine Mammal Protection Act." 2016.
60. NOAA. "Industry Funded Monitoring, An Omnibus Amendment to the Fishery Management Plans of the Mid Atlantic and New England Fishery Management Council." 2016.
61. NOAA. "Law Enforcement Office closes a successful investigation after numerous observers filed complaints against an Alaskan-based vessel." 2017.
62. NOAA. "Looking Forward to Looking Back: Electronic Monitoring in New England Groundfish." Accessed June 2018. [https://www.greateratlantic.fisheries.noaa.gov/stories/2017/04/05\\_eminnewengland.html](https://www.greateratlantic.fisheries.noaa.gov/stories/2017/04/05_eminnewengland.html)
63. NOAA. "National Observer Program FY 2013 Annual Report National Marine Fisheries Service." 2014.
64. NOAA. "National Observer Program: Second National Electronic Monitoring Workshop Transcripts, Video Links, and Program Summaries." 2016.
65. NOAA. Accessed June 2018. <https://www.fisheries.noaa.gov/national/fisheries-observers/electronic-monitoring>.
66. NOAA. Accessed June, 2018. [https://www.greateratlantic.fisheries.noaa.gov/mediacenter/2018/01/25\\_at-sea\\_monitoring\\_2018\\_coverage\\_levels.html](https://www.greateratlantic.fisheries.noaa.gov/mediacenter/2018/01/25_at-sea_monitoring_2018_coverage_levels.html).
67. Pacific Fisheries Management Council. "Decision Summary Document Pacific Fishery Management Council April 5-11, 2018." 2018.
68. Pacific Fisheries Management Council. "West Coast Groundfish Trawl Catch Share Program Five-year Review - Draft." 2017.
69. Piasente, et al. "Electronic onboard monitoring pilot project for the Eastern Tuna and Billfish Fishery." Australian Government Fisheries Research and Development Corporation (2011)
70. Piasente, et al." Assessing discards using onboard electronic monitoring in the Northern Prawn Fishery." Australian Government, Fisheries Research and Development Corporation (2012).
71. Plet-Hansen, et al. "Remote electronic monitoring and the landing obligation - some insights into fishermen' and fishery inspectors' opinions." Marine Policy (2017).
72. Porter Environmental Law Institute. "Fisheries Observers as Enforcement Assets: Lessons from the North Pacific." Marine Policy (2010).
73. Ruiz, J. et al. "Electronic Monitoring Trials in the Tropical Tuna Purse-Seine Fishery." ICES Journal of Marine Science (2015).
74. Sandeman. "North Sea Cod Catch Quota Trials: Final Report 2015." 2016.
75. Satlink. "Human Conditions on Board." Poster presented at the IFOMC conference. 2018.
76. Sterling et al. "Assessing the Value and Role of Seafood Traceability from an Entire Value-Chain Perspective." 2015.
77. Sylvia, et al. "Challenges, Opportunities, and Costs of Electronic Fisheries Monitoring." EDF (2016).
78. The Maritime Executive. "NOAA Shuts Down 22 Fishing Boats over "Codfather" Scandal." November 2017.
79. The Nature Conservancy. "Electronic Monitoring Program Toolkit: A Guide for Designing and Implementing Electronic Monitoring Programs." 2018.
80. The Nature Conservancy. "TNC-RMI Cooperative Pelagic Longline EM Project: End of Contract Summary Report." 2018.
81. The World Bank. "The Sunken Billions Revisited: Progress and Challenges in Global Marine Fisheries." 2017.
82. Verité, "Recruitment Practices and Migrant Labor Conditions in Nestlé's Thai Shrimp Supply Chain" 2015.
83. Wang et al. "Cloud and Machine Learning Technologies for Electronic Monitoring Data Processing and Analysis." EMinformation.com (2017).
84. Watling, Jack. "Fishing observers 'intimidated and bribed by EU crews.'" The Guardian. May 2012.
85. WBUR Radio Boston, 2017. "What's Happening to Cod in New England."
86. WCPFC. "WCPFC Record of Fishing Vessels." Accessed July, 2018.
87. Wilcox, Meg. "The Future of Fishing is Big Data and Artificial Intelligence." Civil Eats. May 2018.
88. World Wide Fund for Nature (WWF). "Electronic Monitoring in Fisheries Management." 2015.

# Catalyzing the Growth of Electronic Monitoring in Fisheries

## Building Greater Transparency and Accountability at Sea

Opportunities, Barriers, and Recommendations for Scaling the Technology



**CEA** CALIFORNIA ENVIRONMENTAL ASSOCIATES

The Nature Conservancy   
nature.org